

**DOE's U.S.  
Transuranium &  
Uranium Registries  
(USTUR): Studying  
Occupational Exposures  
to Plutonium from  
Beginning to End**

*Dr. Tony James*  
*Director, USTUR*  
*Research Professor,*  
*WSU/College of Pharmacy*  
*tjames@tricity.wsu.edu*



*Resource for Internal Actinide Dosimetry and  
Bio-molecular Effects*



## **Early Origins of the US National Plutonium Registry**

---

- 1949 – Hanford Site – “ ... a modest program of postmortem tissue sampling at autopsy ...”
- 1959 – Los Alamos Scientific Laboratory (LASL)
  - Pu analyses for general population.
- Early 60s – USPHS (general population)
  - AEC Rocky Flats (Pu workers).
- Results reported at 7<sup>th</sup> Annual Hanford Symposium on Biology, Richland, WA (1967).



# The United States Transuranium Registry (USTR): Conception

USAEC (DBM) Meeting on "Plutonium Contamination in Man"  
July 25-26, 1966, Denver (Rocky Flats Plant)





## The U.S. Transuranium Registry: Birth & Infancy

---

- **1968 – National Plutonium Registry (NPR)**
  - Run by Hanford Environmental Health Foundation (HEHF).
  - W. “Dag” Norwood MD, NPR Director.
  - Distinguished Advisory Committee (including Robley Evans, Herb Parker, Wright Langham).
- **Mission: “... serve as a focal point for acquiring and providing the latest, most precise information about the effects of transuranic elements in man ...” – specifically plutonium workers.**
- 1970 – Name changed to U.S. Transuranium Registry (USTR).
- 1972 – John Norcross MD, Director.
- 1976 – Bryce Breitenstein MD, Director.



## The U.S. Transuranium Registry: Active Adolescence

- 1978 – 15,000 transuranium element workers identified
  - Hanford and LASL radiochemistry operations consolidated at LANL (Jim McInroy) – separate DOE funding from USTR.
  - Rocky Flats Plant continued separate radiochemistry and autopsy programs (Bob Bistline) – separate DOE funding from USTR.
- > 1,000 authorizations for autopsy.
- 93 autopsies performed (to date).
- 1978 – US Uranium Registry (USUR) formed at Hanford – Bob Moore MD, Director.
- 1982 – USTR & USUR combined at HEHF (forming USTUR) – Margery Swint MD, Director.



## The U.S. Transuranium & Uranium Registries: Coming of Age

- **1992 – All USTUR, National Human Tissue Repository (NHRTR), and National Radiobiological Archive (NRA) operations consolidated at Washington State University (WSU) – under the College of Pharmacy.**
  - New 3-y DOE grant cycle – to WSU.
  - Ron Kathren CHP, USTUR Director (WSU, Tri-Cities).
  - John Russell, NHRTR/NRA Director (WSU, Tri-Cities).
  - Roy Filby, PhD, Radiochemistry Director (WSU, Pullman – Nuclear Radiation Center).

- **1993 – Registries' 25<sup>th</sup> Anniversary Compendium of Publications:**





## The U.S. Transuranium & Uranium Registries: Middle Age

- **1995 – 2004: DOE renewed WSU's grant for USTUR's research, management and operation (3-y grant cycle).**
  - Ron Kathren CHP, Director (1995 – 1998).
  - Ron Filipy PhD, USTUR Director (1998 - 2004).
  - John Russell, NHRTR/NRA Director (retired 2003).
  - Sam Glover PhD/Jim Elliston PhD, Radiochemistry Directors (WSU, Pullman – Nuclear Radiation Center).

• **1992 – 2003: USTUR Publications Featured in Health Physics Journal:**

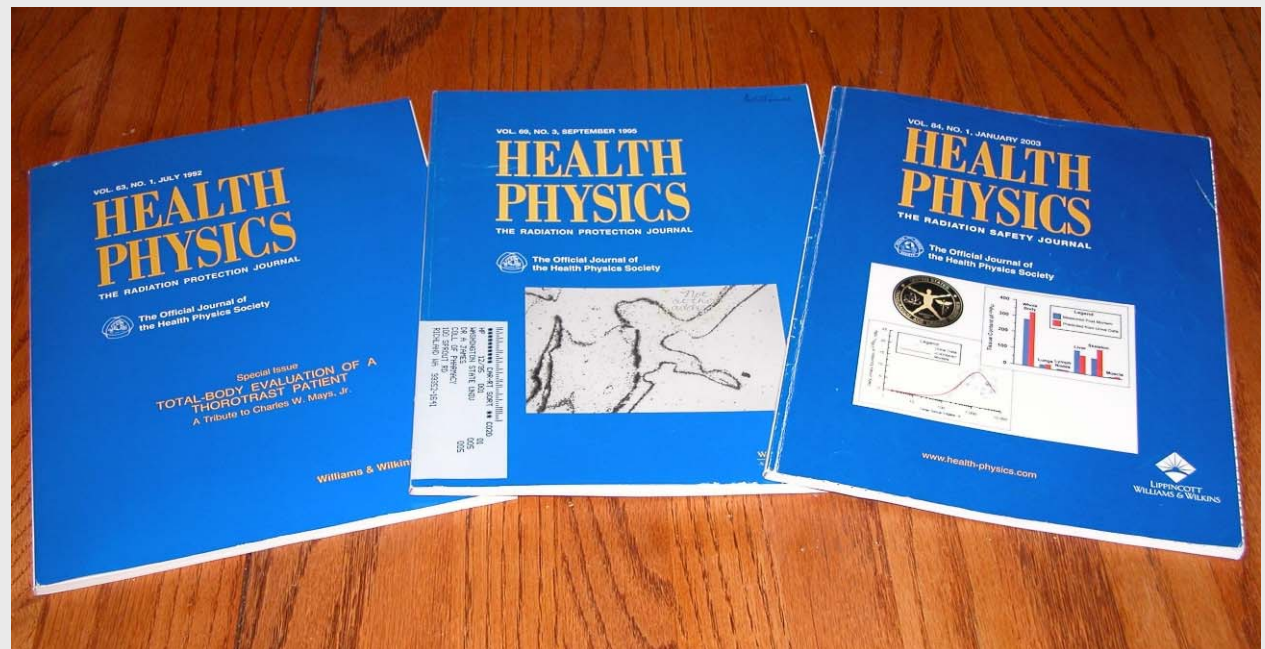



## **The USTUR/NHRTR/NRA: Maturity & “Hereafter”**

- **2005 – 2010: DOE/EH-53 renewed WSU’s grant for USTUR’s research, management and operation (new 5-y grant cycle).**
  - Tony James PhD, Director.
  - Tanya Wood, co-PI National Human Tissue Repository (NHRTR).
  - Chuck Watson PhD, NRA Database Consultant.
  - Radiochemistry operations – to be reviewed by external consultant [Isabelle Fisenne PhD, Environmental Measurements Laboratory (EML, NY)/Dept. of Homeland Security – retired].
- **Current Registrant Status:**
  - 364 deceased tissue donors;
  - 120 still-living Registrants;
  - Average age now about 85 years!





# Who is Tony James? - From 1960's Experimental Microdosimetry of Pu in Skeleton of Laboratory Rat to Pu in Human Tissues up to 60-y Post Intake!

MRC/NRPB, UK  
(1970-1988)

Battelle PNL,  
Richland, WA  
(1988-1994)

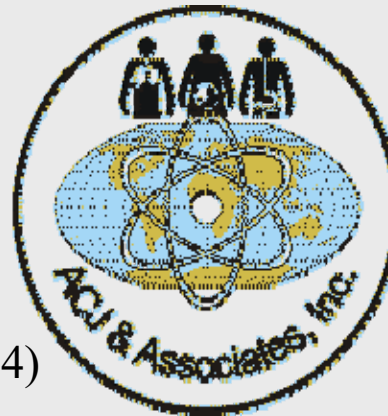

USTUR/WSU  
Richland/Pullman,  
WA (2004 - 2010)

(1995-2004)

Royal Free Hospital  
School of Medicine,  
London, UK (1965-69)





## When Did USTUR Whole-Body Donors Get Their Intakes?

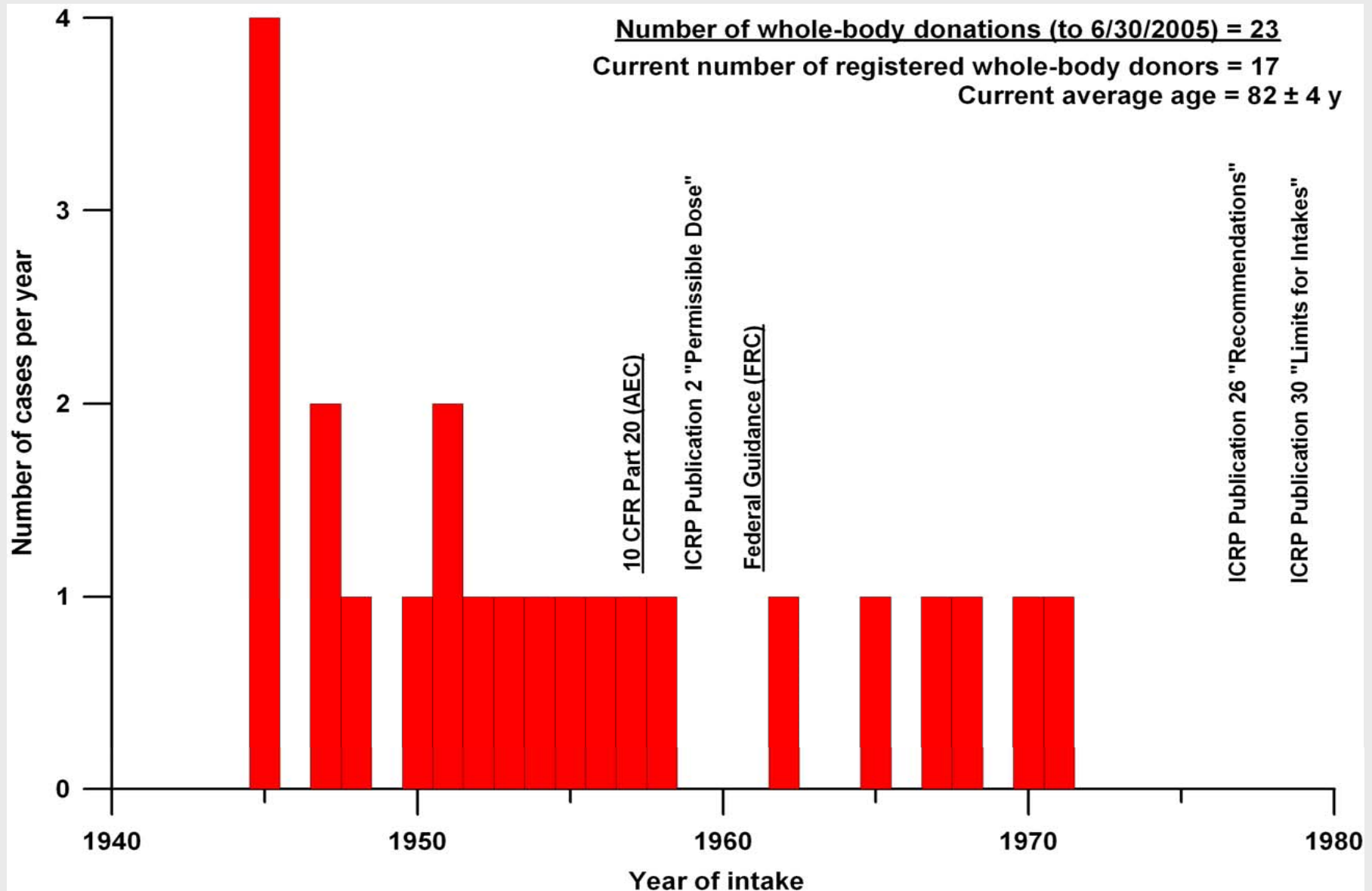



## How Do USTUR Registrants' Tissue Burdens Compare With MAYAK Workers'?

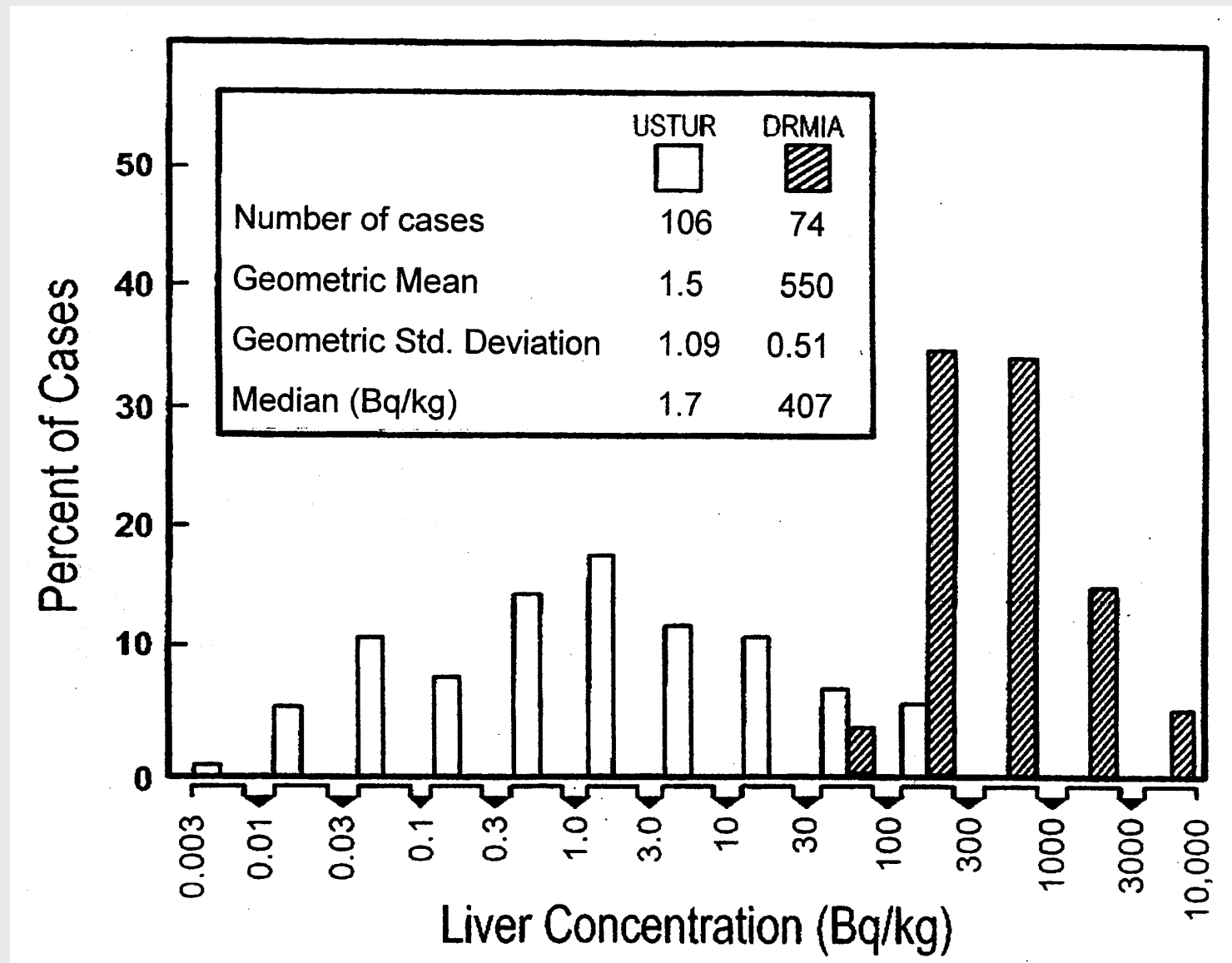



## How Were Intakes Estimated? – Empirical Model for Pu Excretion in Urine – Human Injection Study (1949 – 1953)

In 1949, Wright Langham (Los Alamos) injected a group of “terminally ill” patients with soluble  $\text{Pu}(\text{NO}_3)_4$  – and followed their urinary excretion over the next 4 y.

In 1976, John Rundo (Argonne Laboratory) found two of these original patients (HP-3 & HP-6). Their Pu excretion was still measureable!

Figure adapted from Jones, S.R. Derivation and validation of a urinary excretion function for plutonium applicable over tens of years post intake. *Radiat. Prot. Dosim.* 11:19-27 (1985).

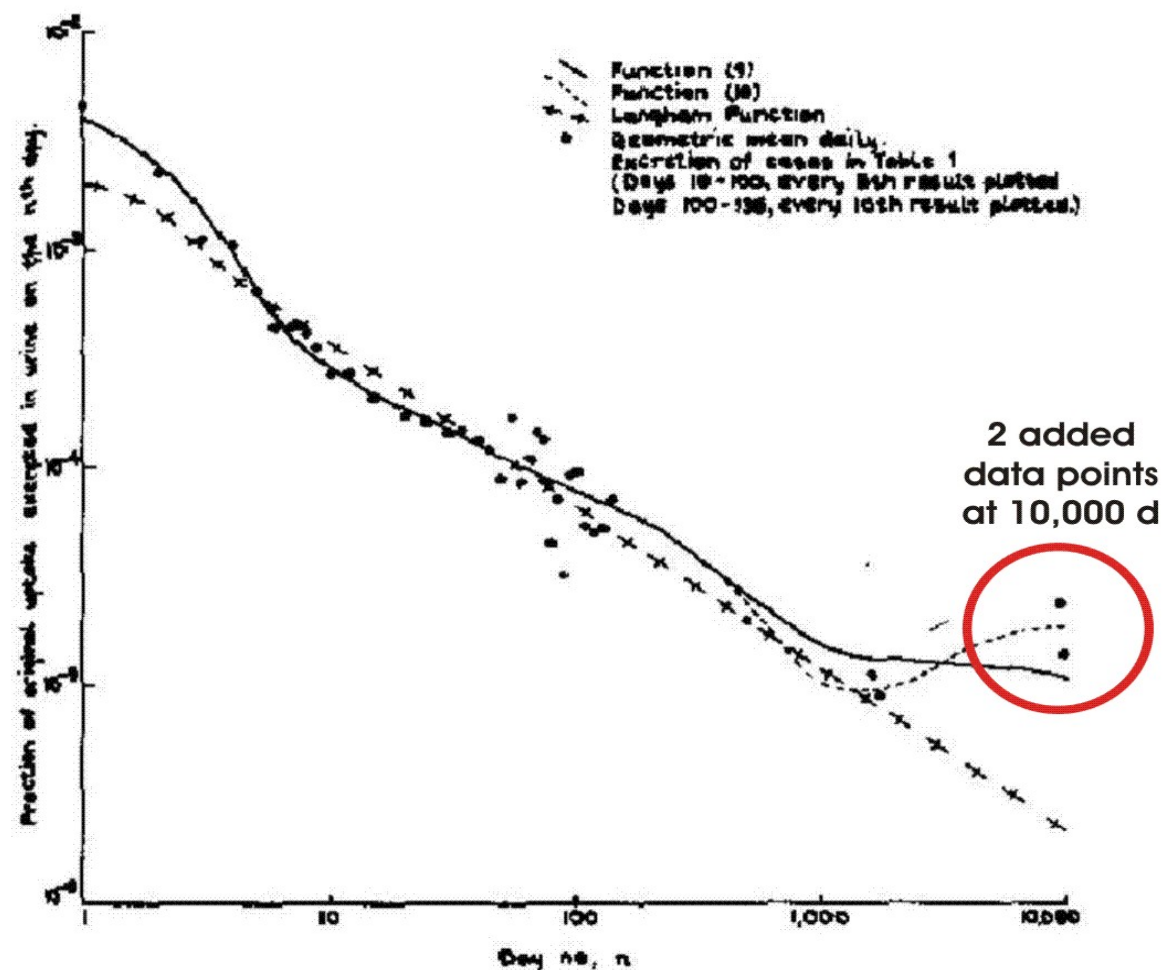

Figure 1. Time development of excretion functions.



# Current Basis for Pu Internal Dose Assessment

- ICRP Publication 67 (1993) Biokinetic Model for Systemic Behavior of Plutonium.

- USTUR data contributed significantly to development of ICRP's Pu (also Am, U) biokinetic models.

- Used in conjunction with 'intake' model, e.g., ICRP Publication 66 (1994) Human Respiratory Tract Model (HRTM).

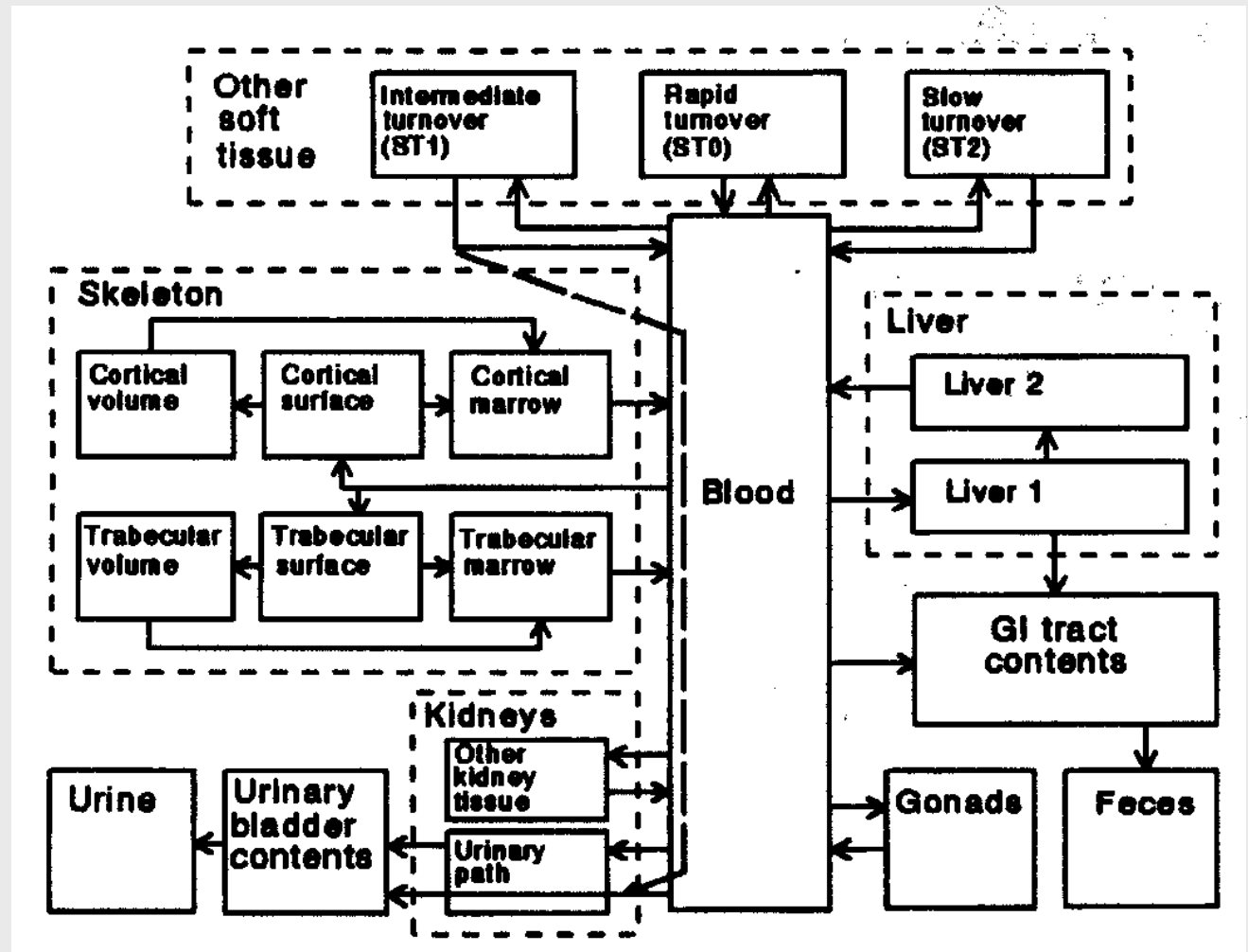

Representation from Leggett et al. Radiat. Res. 164, 111-122 (2005).



# Key Feature of HRTM (ICRP 66) – Competitive Clearance Mechanisms!

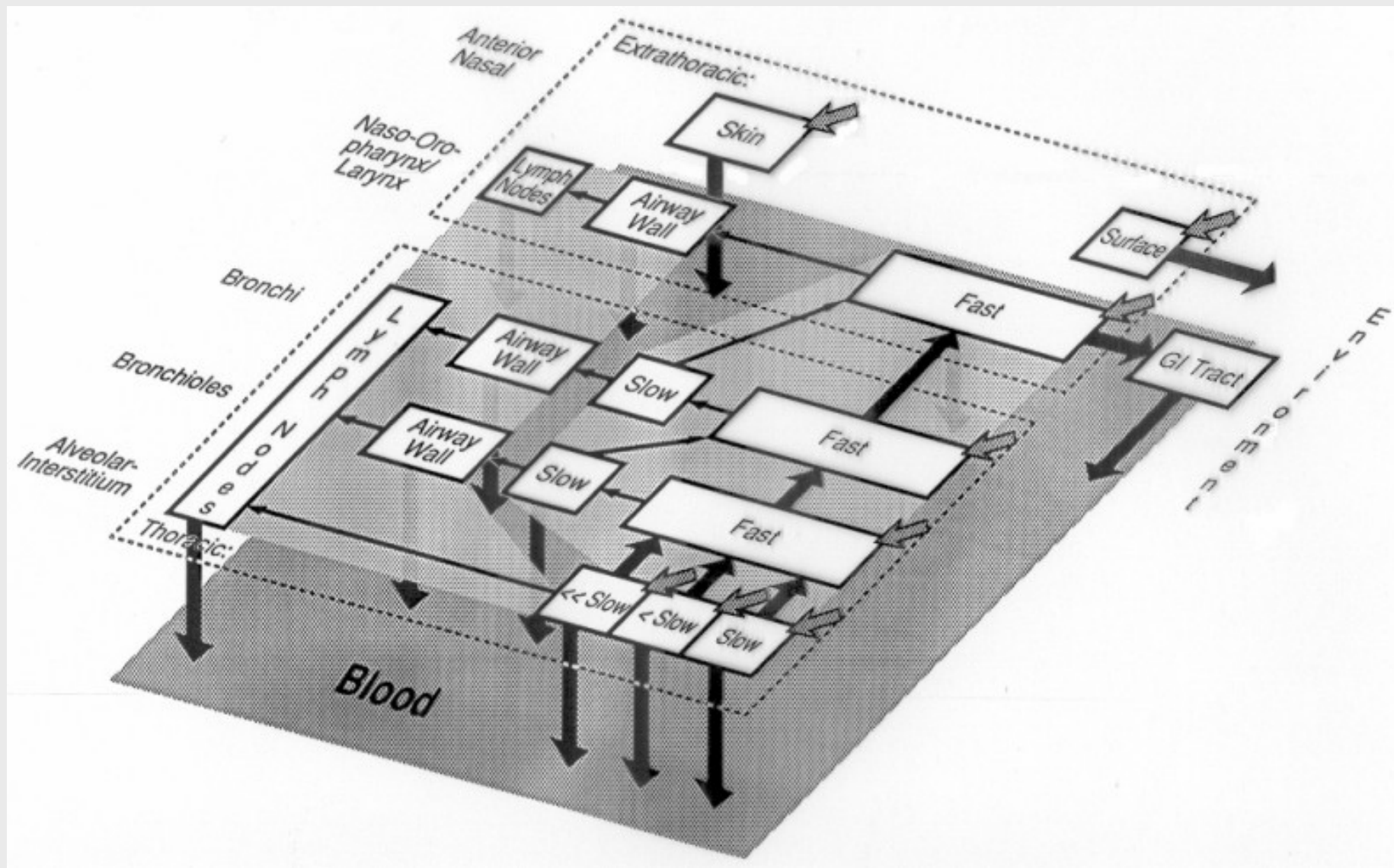



# Key Features of ICRP's New "Biokinetic" Models

## Uranium Model

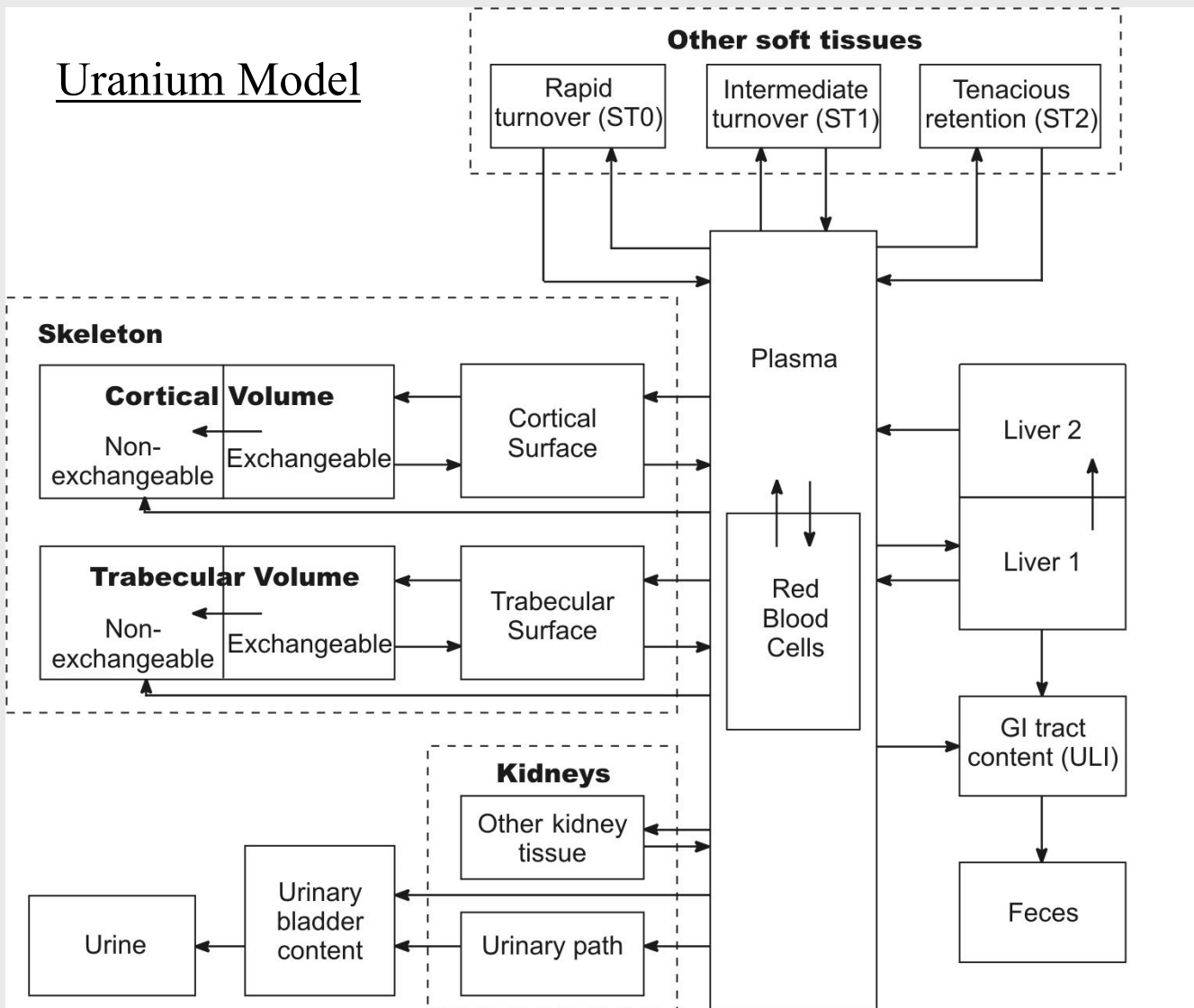

• *Explicit excretion pathways.*

• *Recycling from organs back into blood.*

• *Organ uptake determined by competing rates.*



## The USTUR 2005-2010: Key Goals

---

- Utilize the body of USTUR data to validate new methodologies used at DOE sites for assessing ‘realistic’ tissue doses in individual cases.
- Quantify the variability in behavior of transuranic materials among individuals.
  - Only the USTUR has enough (high resolution) human data to do this!
- Based on exposure data going back to the 1940s, examine the adequacy of protection standards utilized for plutonium workers in the early years of the nuclear industry.
- Examine the ‘claimant favorable’ assumptions made in adjudicating EEOICPA compensation claims – and their implications for ‘litigated’ cases!
- Determine the effectiveness of chelation therapy.
  - USTUR has the data to support a human experience-based predictive model.





## **Illustrations of USTUR's 2005-2010 Facilities & Tasks**

---

- USTUR's facilities.
- Research integration with – and improvement of – DOE site internal dose assessments.
  - Internal dose assessment software used by DOE sites – and NIOSH/OCAS' EEOICPA dose reconstructors.
- Effectiveness of chelation therapy.
  - Why this is still an 'issue'.
- Quantify the variability in behavior of transuranic materials among individuals.
  - USTUR's new quantitative approach.
- Examine the 'claimant favorable' assumptions made in adjudicating EEOICPA compensation claims – and their implications for 'litigated' cases!
- **USTUR Registrant longevity!**



## USTUR Tri-Cities Laboratory Facilities (Richland Airport)



Receiving lab – showing several low temperature ( $-70^{\circ}\text{C}$ ) chest freezers, and stored radiochemical sample solutions.





## USTUR Tri-Cities Laboratory: Tissue Dissection Facility

- Bone and other intricate dissections carried with laminar flow hood protection.
- Special procedures will be developed to extract red bone marrow – for separate radio-isotope assay.
- Dissected tissues stored at  $-70\text{ }^{\circ}\text{C}$  – for potential molecular marker studies.





## USTUR Tri-Cities Laboratory: Tissue Dissection Facility

- **Section of lumbar vertebral bodies taken from routine autopsy (partial body donor).**
- **Aim to separate (quantitatively) red bone marrow from trabecular bone.**





## The 'Gold Mine' – USTUR/WSU Tri-Cities Registry Room!





## USDOE's Implementation of ICRP Publication 60/68 Recommendations

- DOE Standard: Internal Dosimetry. DOE-STD-1121-98. Washington, D.C.: U.S. Department of Energy; 1999 –
  - Allows use of “best science” biokinetic models in regulatory dose assessments.
  - Retains **10-CFR-835** tissue weighting factors – and treatment of “Remainder Tissues”.
- In July 2001, DOE's Office of Worker Protection Policy & Programs (EH-53) contracted ACJ & Associates, Inc. to develop [with the UK National Radiological Protection Board (NRPB)] a new ICRP60/68-based internal dosimetry and bioassay analysis code for use by DOE-regulated sites:
  - **IMBA Expert™ USDOE-Edition;**
  - Phase II (Final) version delivered April, 2004.



# IMBA Expert™ USDOE-Edition

- Aim:** To provide USDOE sites with standardized methods for dealing with bioassay measurements (using the UK NRPB's QA'd IMBA modules) –
- more powerful and flexible than existing software.

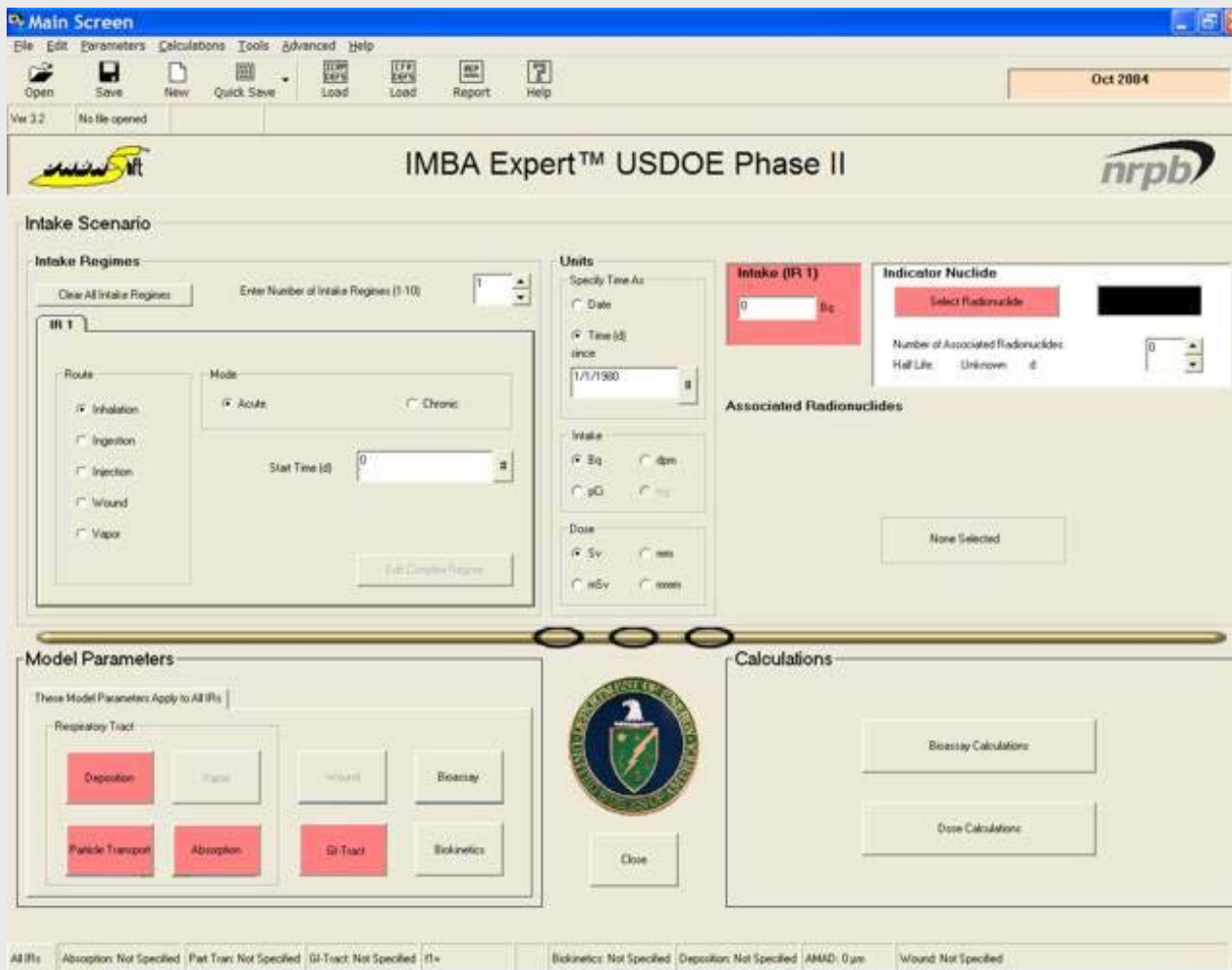



# Example Use of IMBA Expert™ USDOE-Edition: The HAN-1 Case

Measurement Time (d)	N/A	Measurement Value(pCi)	Data Type	Measurement Error	Error Distributor
5.000E-01		1.300E+03	Real	1.300E+02	NORM
1.500E+00		1.200E+03	Real	1.200E+02	NORM
3.000E+00		1.350E+03	Real	1.350E+02	NORM
7.000E+00		1.300E+03	Real	1.300E+02	NORM
2.050E+01		1.250E+03	Real	1.250E+02	NORM
3.500E+01		1.200E+03	Real	1.200E+02	NORM
4.850E+01		1.200E+03	Real	1.200E+02	NORM
6.950E+01		1.300E+03	Real	1.300E+02	NORM
1.165E+02		1.300E+03	Real	1.300E+02	NORM

Most likely "fit" to HAN-1 <sup>241</sup>Am-in-lung data assuming ICRP default HRTM parameter values (Type 'S').





## The HAN-1 Case: Optimizing the Data Fit

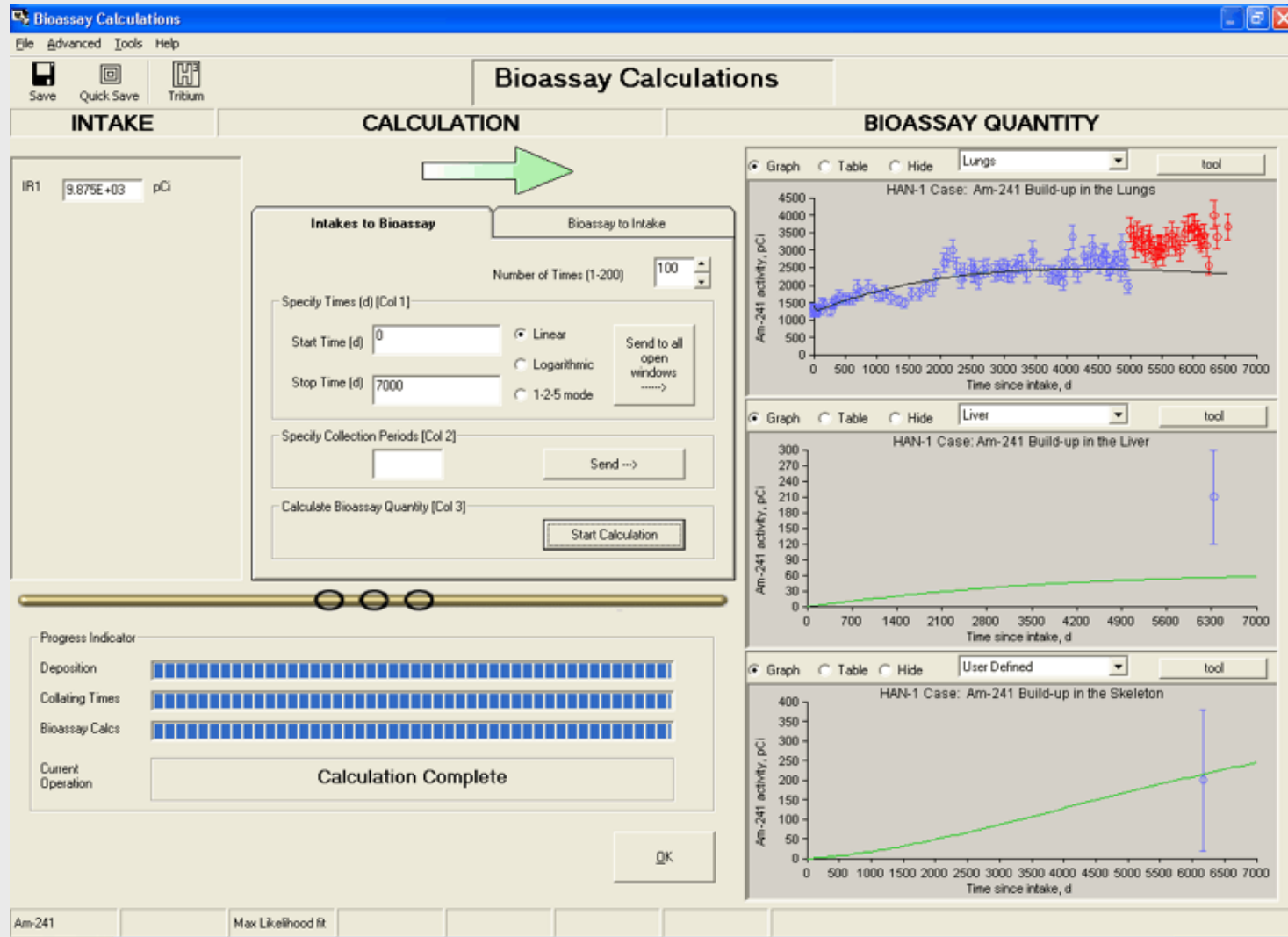

Improved overall "fit" to the HAN-1 data obtained by modifying parameter values in the HRTM.



## USTUR Case # 0102: DOE's Human $^{241}\text{Am}$ Phantom

- **Half skeleton – encased in tissue equivalent plastic – with simulated lungs.**
- **Died age 50 – malignant melanoma.**
- **Skeletal burden approx. 2 kBq (50 nCi)  $^{241}\text{Am}$ .**
- **Phantom distributed to DOE “in vivo” labs – and internationally.**





## USTUR Case # 0990: Whole Body Donor

- PNNL low-background “in vivo” counting facilities (thin planar Ge).

- Pu inhalation – with 30,000 ppm  $^{241}\text{Am}$ .

- Counters positioned for liver.





## **USTUR Case # 0990: Whole Body Donor – Looking Inside**

---

- **Body flown to Tri-Cities (from Denver).**
- **Full autopsy and internal organ prosection carried out by licensed medical examiner.**
- **In this case, liver was tucked up high under rib cage.**
- **Radiochemistry will provide all organ contents (Pu isotopes and  $^{241}\text{Am}$ ).**



# Why is Chelation Therapy for Internal Actinide Deposition Still of Interest?



Listen to the Star Spangled

Banner performed by Albie Powell of the U.S. Army Band. Sound clip courtesy of the National Archives.



## Press Release

August 11, 2004

FOR IMMEDIATE RELEASE

CONTACT: MMRS National Program Manager at [fema-mmrsadmin@dhs.gov](mailto:fema-mmrsadmin@dhs.gov)

### FDA Approves Drugs to Treat Internal Contamination from Radioactive Elements

Washington, DC — The Food and Drug Administration (FDA) today announced the approval of two drugs, pentetate calcium trisodium injection (Ca-DTPA) and pentetate zinc trisodium injection (Zn-DTPA) for treating certain kinds of radiation contamination. The FDA is approving these two drugs as part of its ongoing effort to provide the American public the best available protection against nuclear accidents and terrorist threats.

The FDA has determined that Ca-DTPA and Zn-DTPA are safe and effective for treating internal contamination with plutonium, americium, or curium. The drugs increase the rate of elimination of these radioactive materials from the body.

"The approval of these two drugs is another example of FDA's readiness and commitment to protecting Americans against all terrorist threats," said Dr. Lester M. Crawford, Acting FDA Commissioner.

• ***Homeland Security*** – precipitates FDA approval (2004) of Ca- and Zn-DTPA – after 50-y AEC/ERDA/DOE experience of therapeutic use as “experimental” drug!



## Autoradiographic Visualization of Bone Growth/Chelation Dynamics in the Weanling Rat

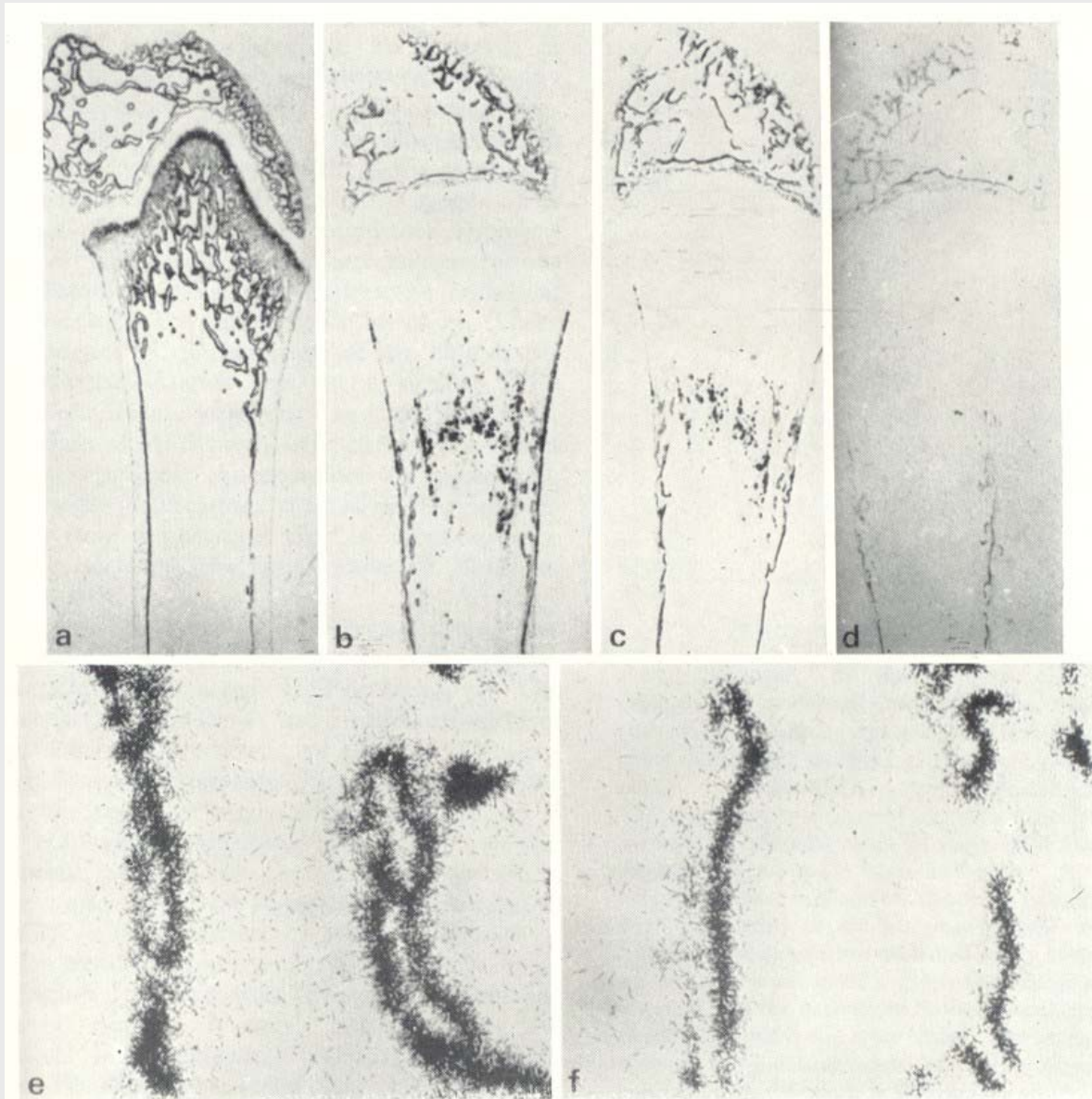

From James and Taylor, 1971

### Key

i.v. injection of citrate-buffered (monomeric)  
 $^{239}\text{Pu}(\text{NO}_3)_4 - 5 \mu\text{Ci/kg}$

- a. 1 d untreated
- b. 21 d untreated
- c. DTPA at 7 d
- d. DTPA at 30 min
- e. From [b] - untreated
- f. From [c] - DTPA 7 d



# Case 0269 – $^{239/240}\text{Pu}$ -in-Urine Data

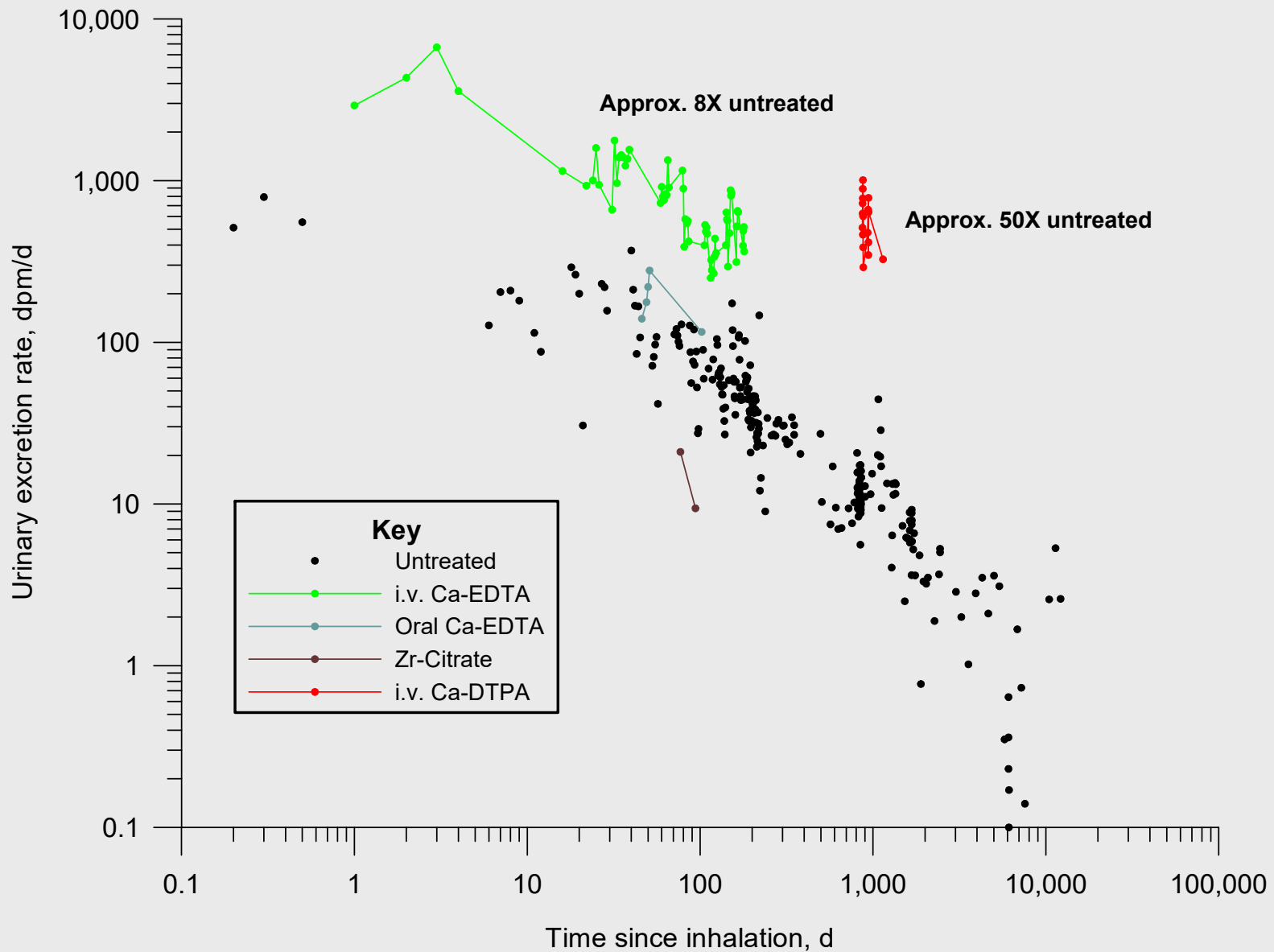



# Case 0269 – $^{239/240}\text{Pu}$ -in-Feces Data

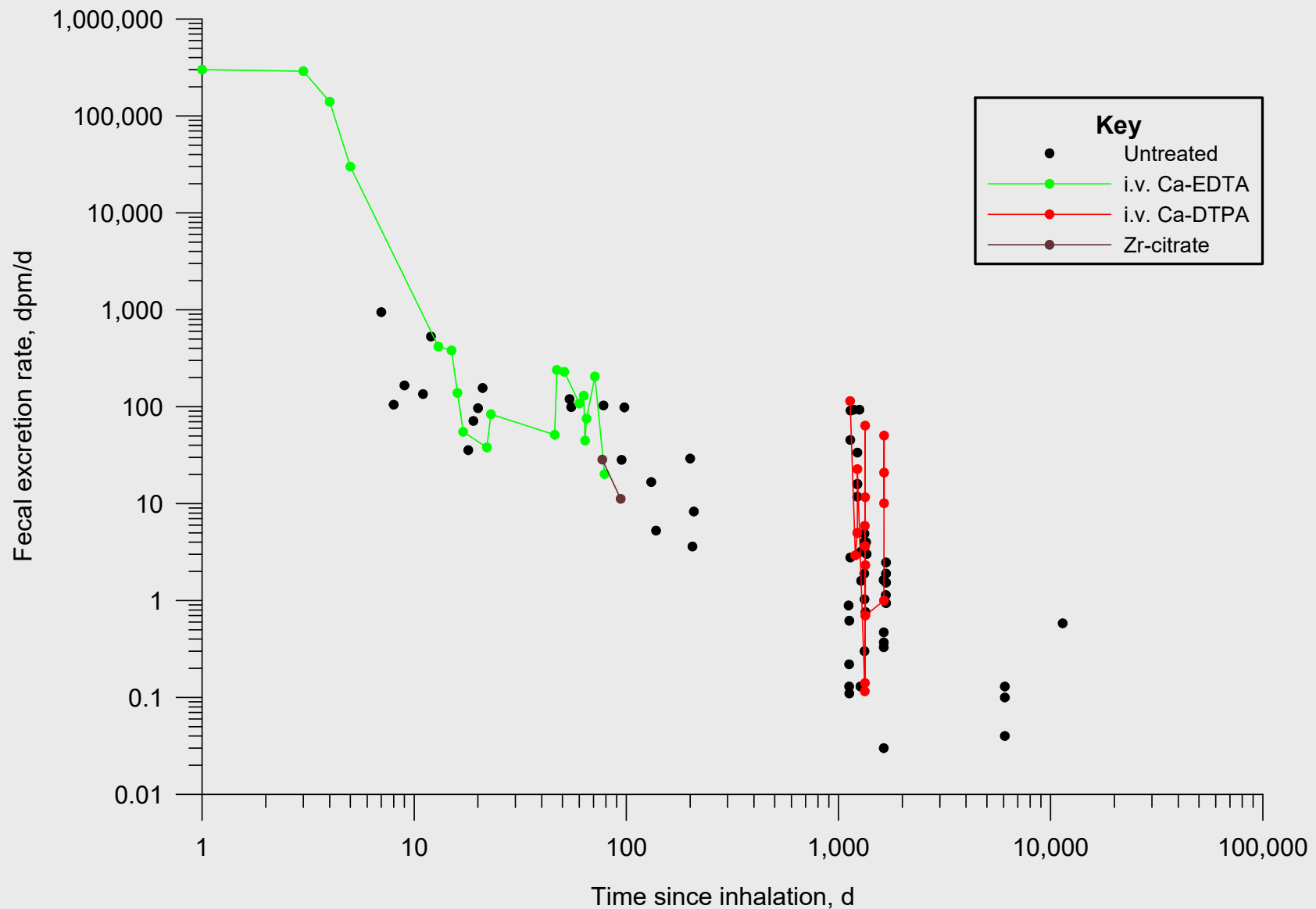





# CASE 0269 Software Toolbox – 1. IMBA Expert™ USDOE-Edition



## Case 0269 Software Toolbox – 2. Algorithm for Solving Large Model

### Requirements

1. Solve model in time steps – corresponding to urine/fecal sampling interval.
2. Vary ALL parameter values.
3. Evaluate “goodness-of-fit” to urine/fecal data.
4. *Fast cycle time* – for iterative “parameter seeking”.
  - Birchall & James (1989) – with modern 32-bit compiler.

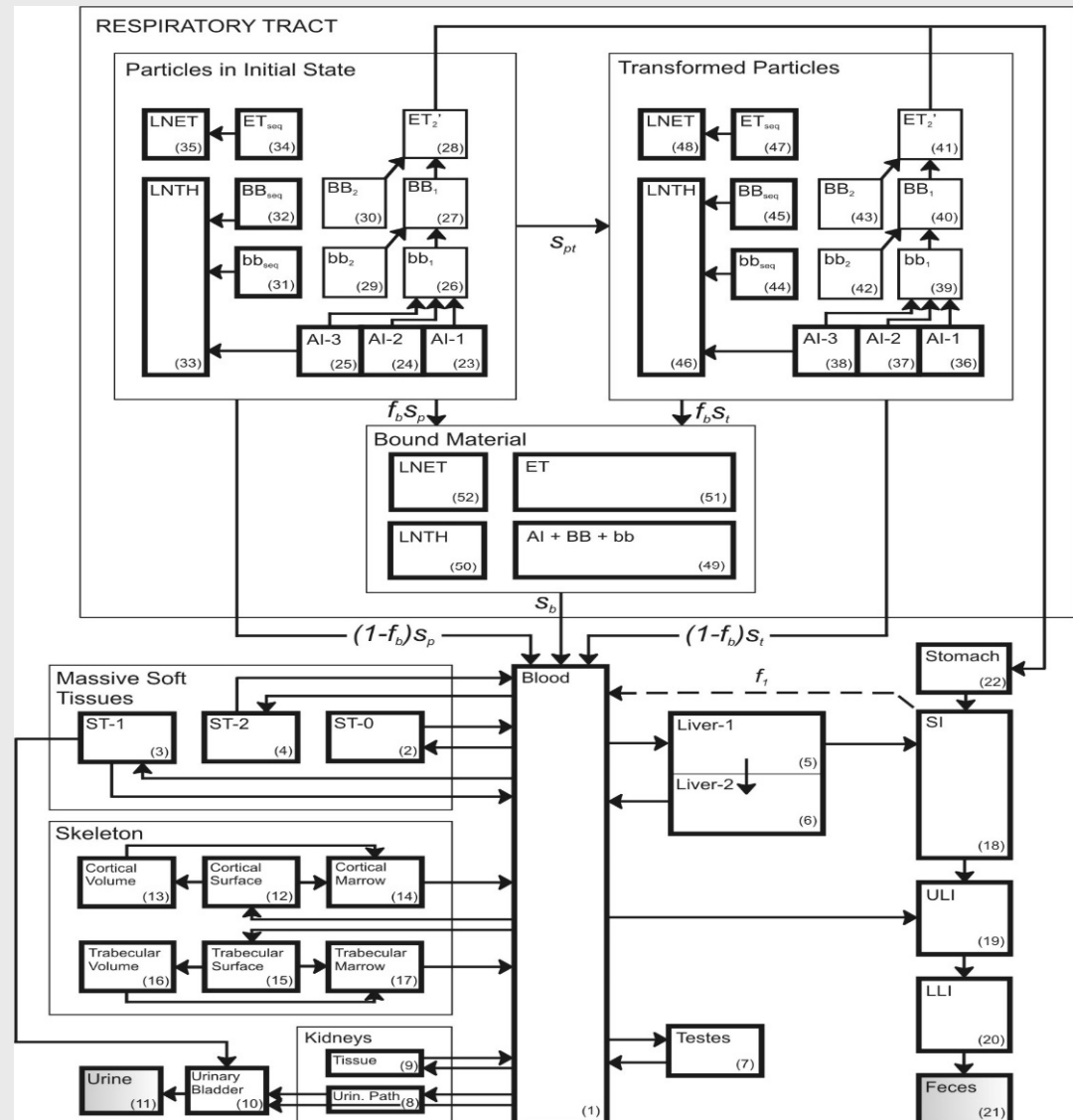



# ICRP 67 Pu Biokinetic Model – Potential Chelation Pathways

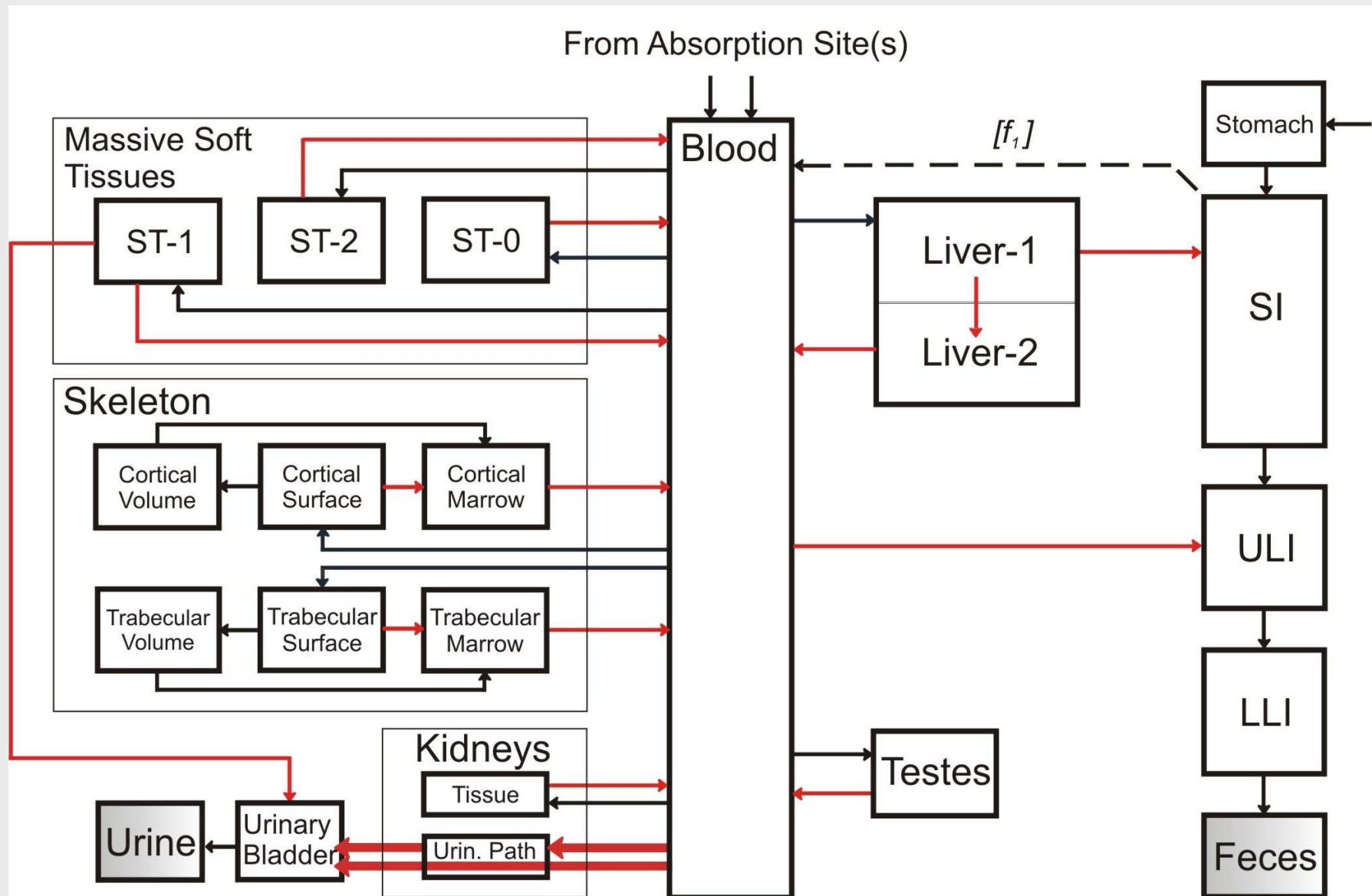



## Case 0269 – IMBA Expert™ Analysis

- *Exclude urinary and fecal data clearly influenced by chelation.*
- *Analyze simultaneously:*
  - urinary and fecal bioassay data
  - lung (and lymph node) Pu contents at time of death
  - “Find best fit” – by varying aerosol and absorption parameter values required to minimize total  $\chi^2$ .
  - *Result -*

Intake = 58 kBq

AMAD = 2  $\mu\text{m}$

$f_1 = 0.0005$

$s_p = 4 \text{ d}^{-1}$

$s_{pt} = 100 \text{ d}^{-1}$

$s_t = 0.02 \text{ d}^{-1}$

$f_b = 8\%$

$S_b = 2 \times 10^{-4} \text{ d}^{-1}$

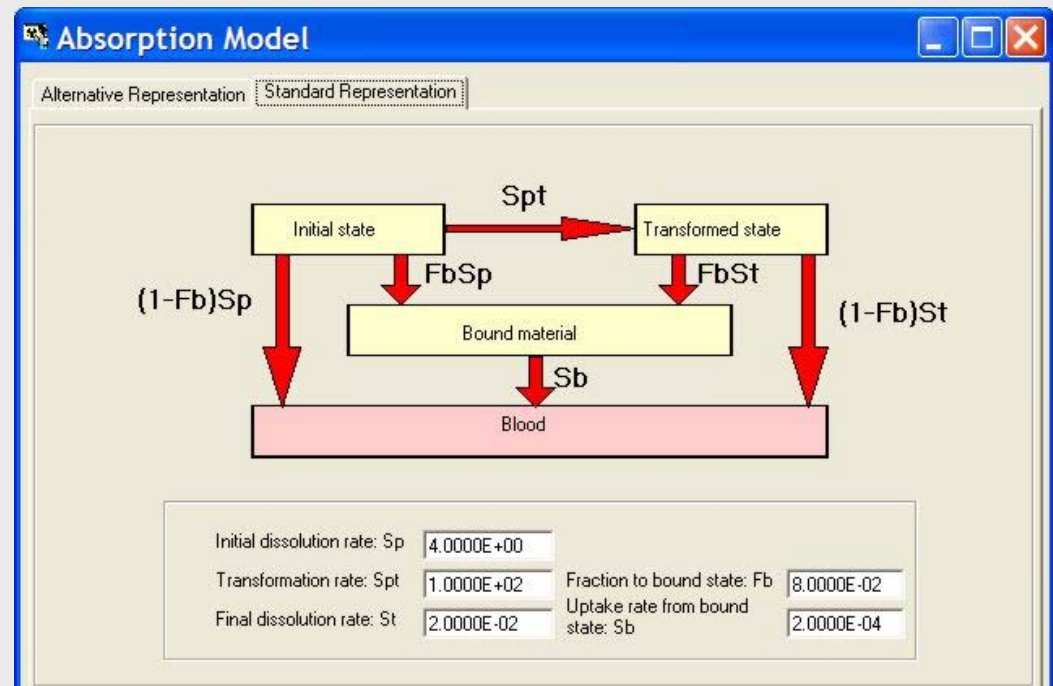



# “Fitted” – $^{239}\text{Pu}$ Activity Measured in Lungs (@14,054 d)

## Graph Tool for Lungs

View

Case 0269 - Lung Retention of Pu-239

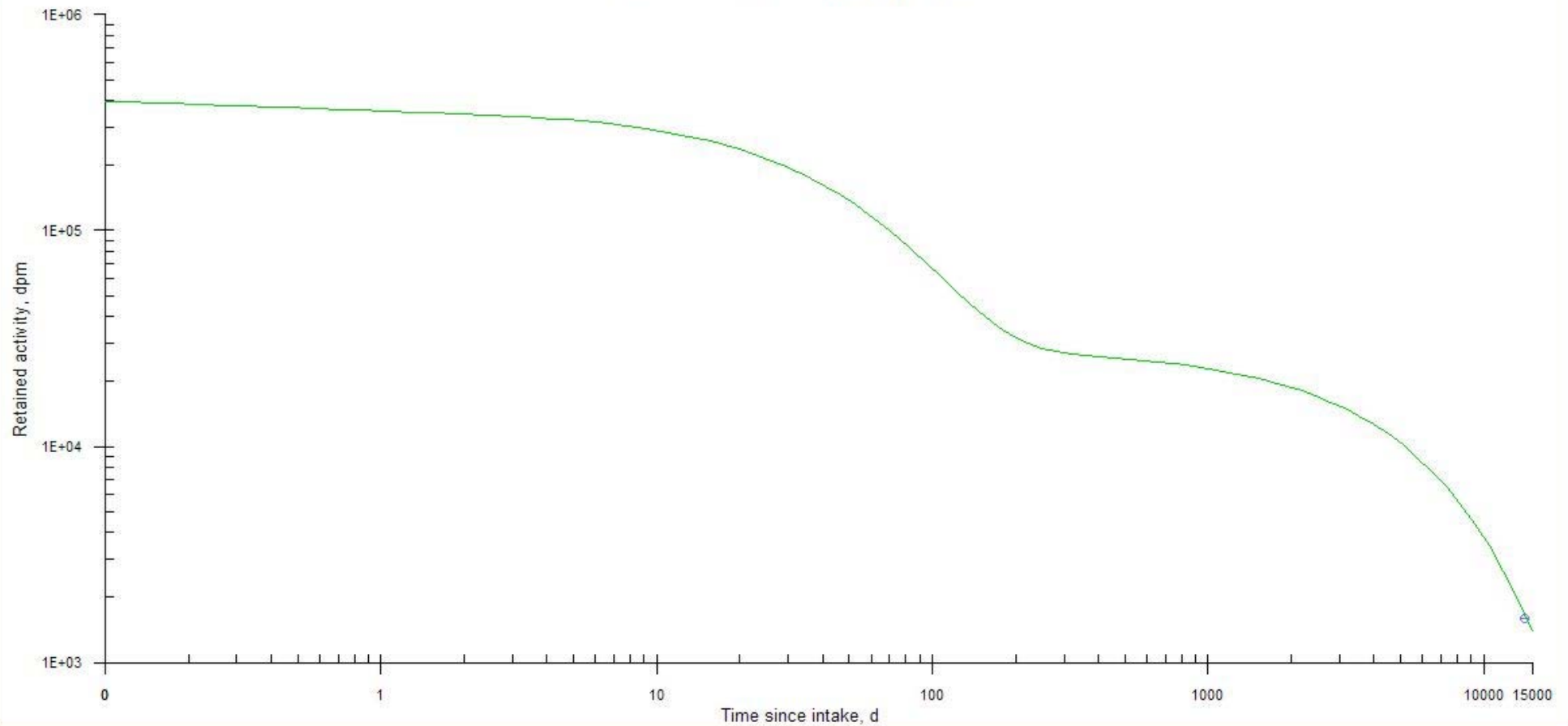



## “Best Fit” – Predicted vs. Measured Pu-in-Urine

### Assumes

1. No treatment.
2. ICRP-Recommended parameter values in ICRP67 biokinetic model (“hard wired” in software).

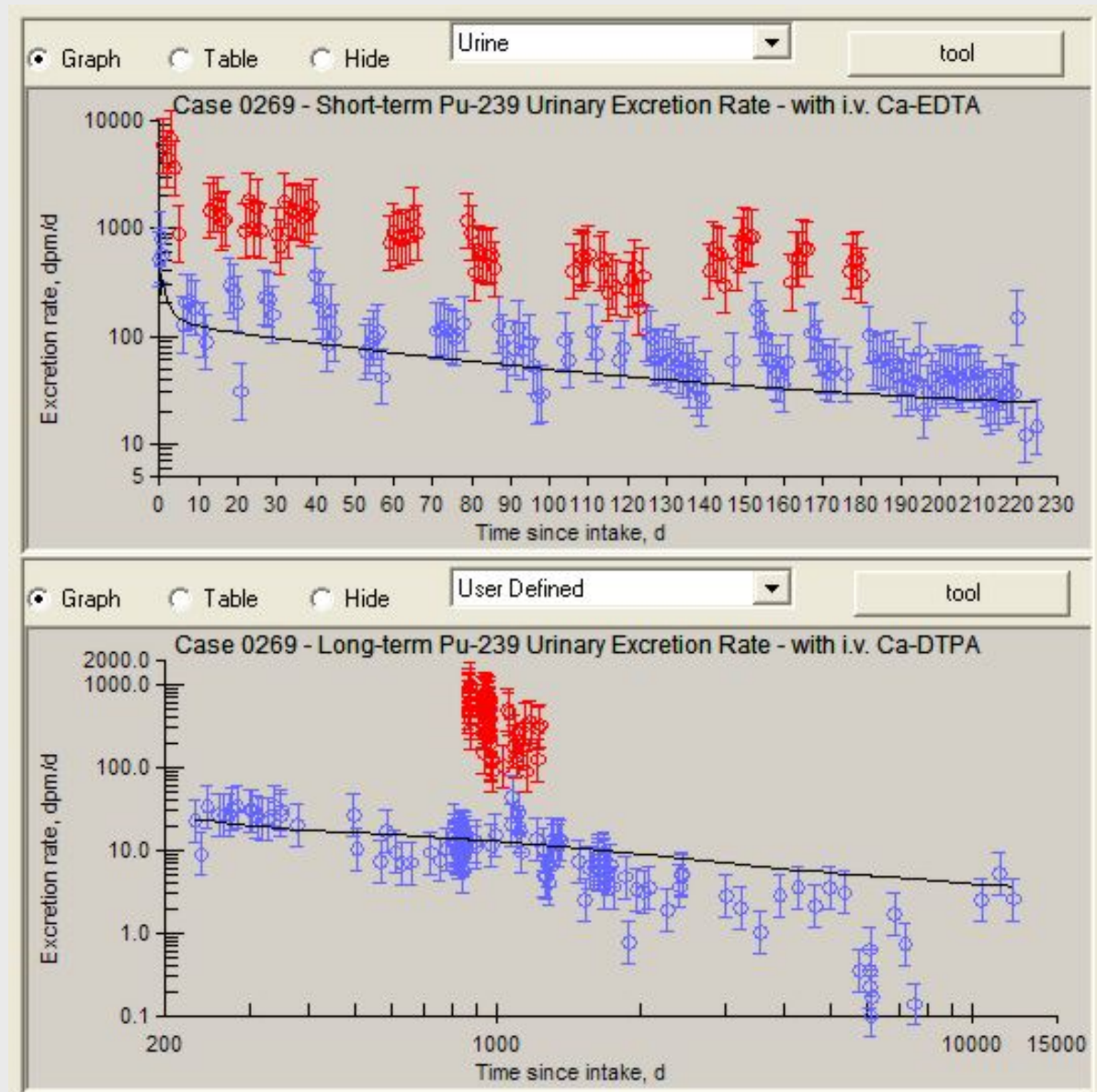



## Method Used to “Fit” Parameter Values

**Chi-Square Hypersurface as a Function of Ca-EDTA  
Urinary Enhancement Factors - Final Optimization - 11/17/04**

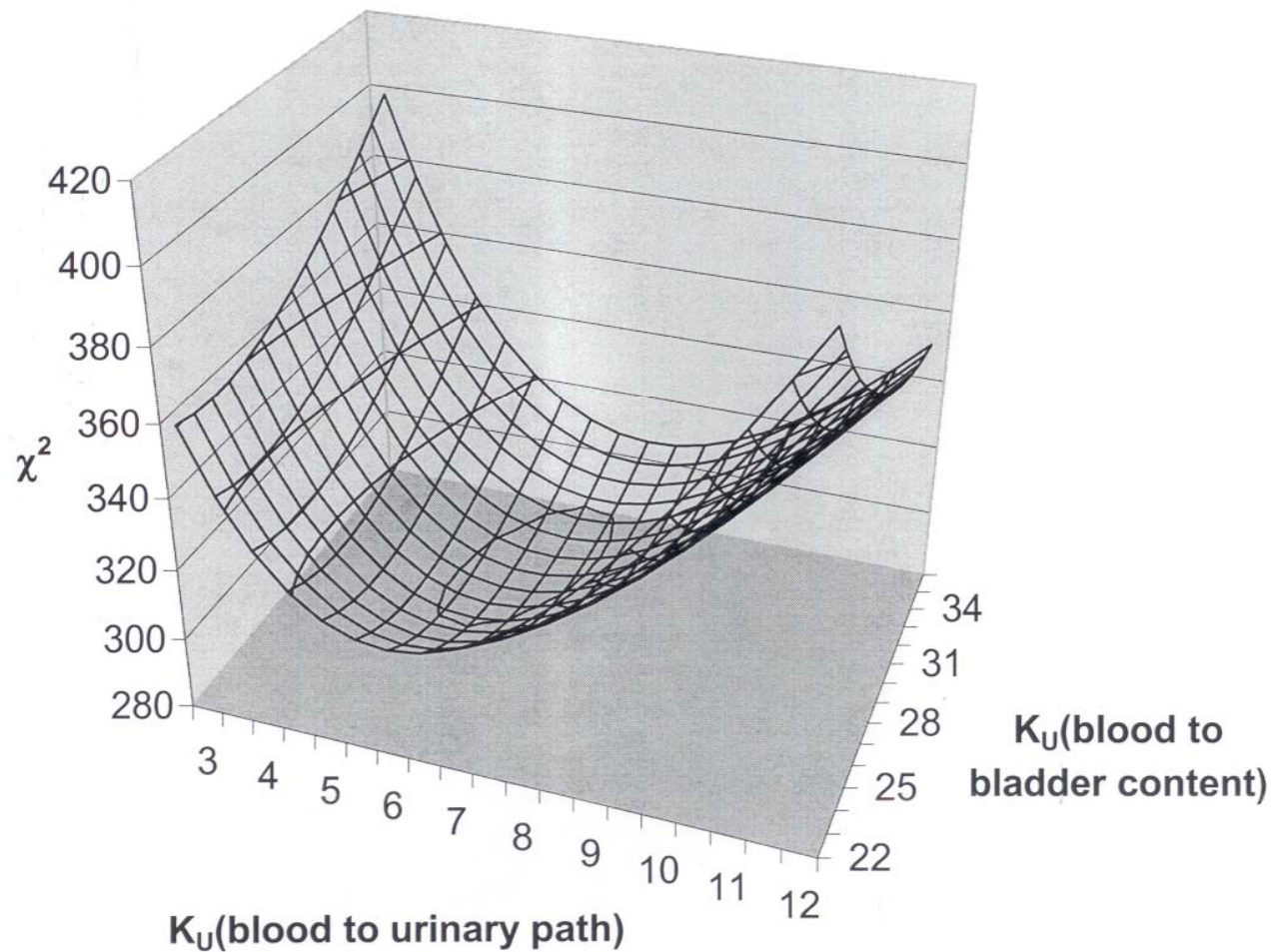



# Ca-EDTA: Interim Model of Pu-in-Urine Excretion

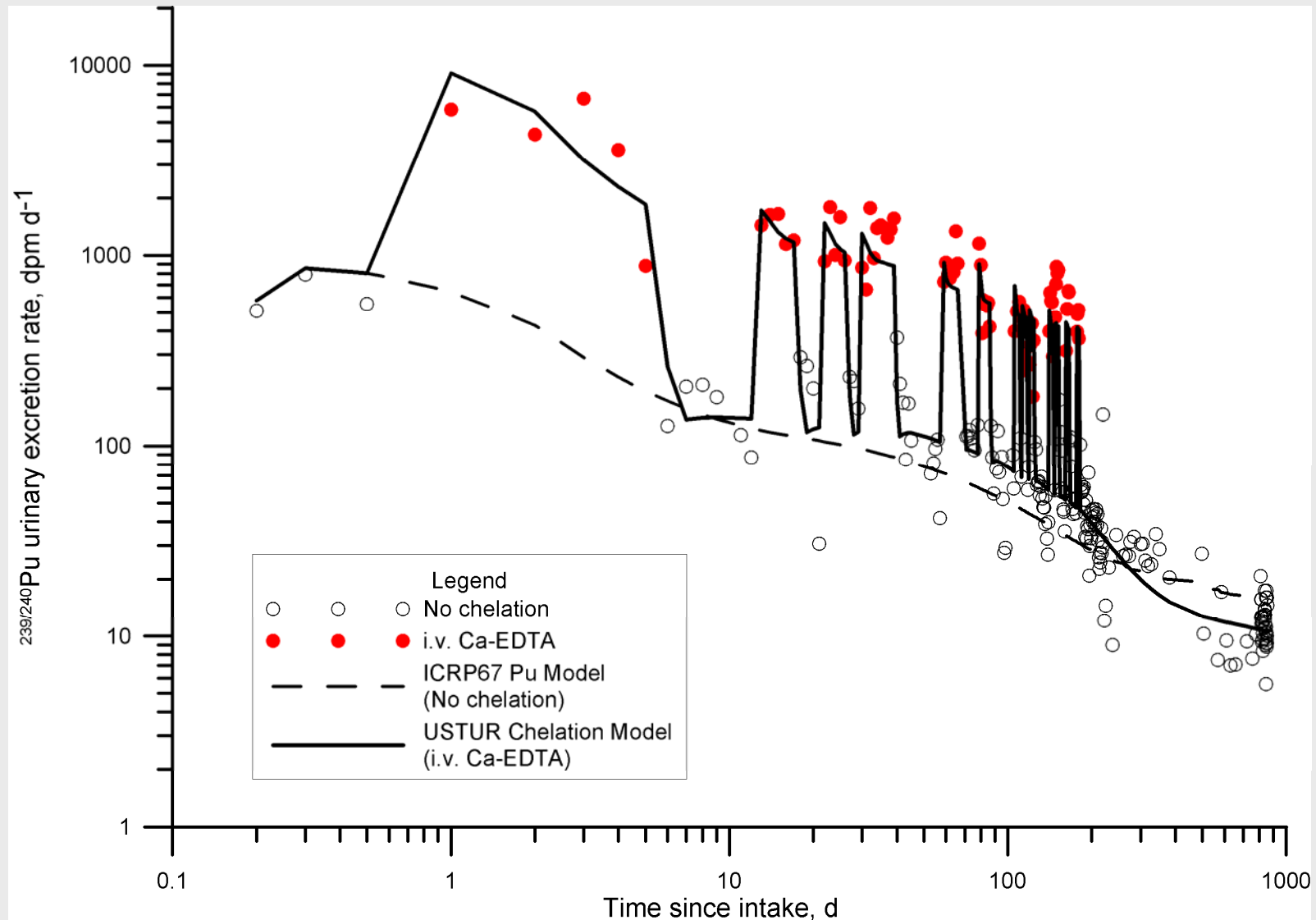





# Ca-DTPA: Interim Model of Pu-in-Urine Excretion

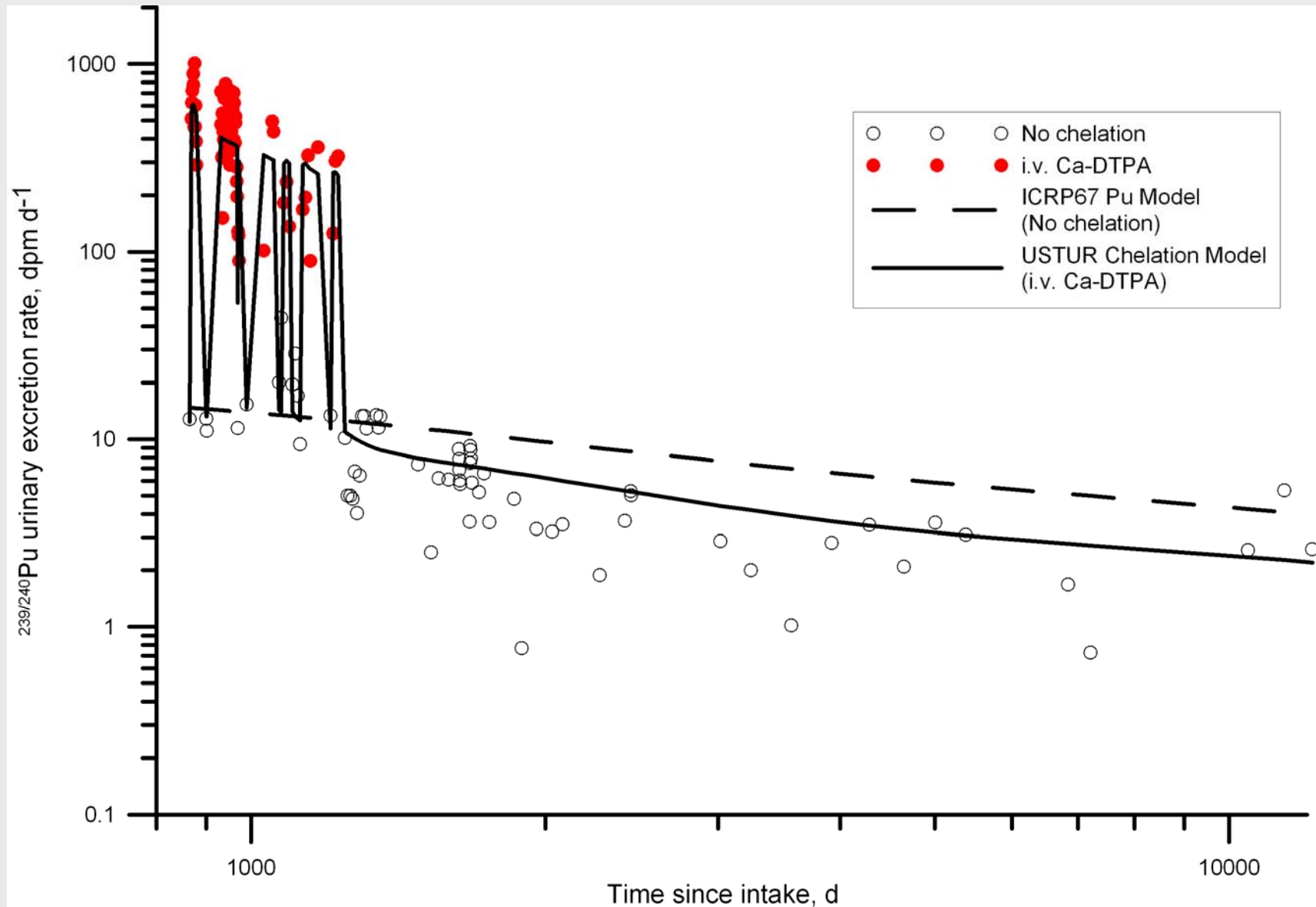



# Ca-DTPA: Interim Model of Pu-in-Feces Excretion

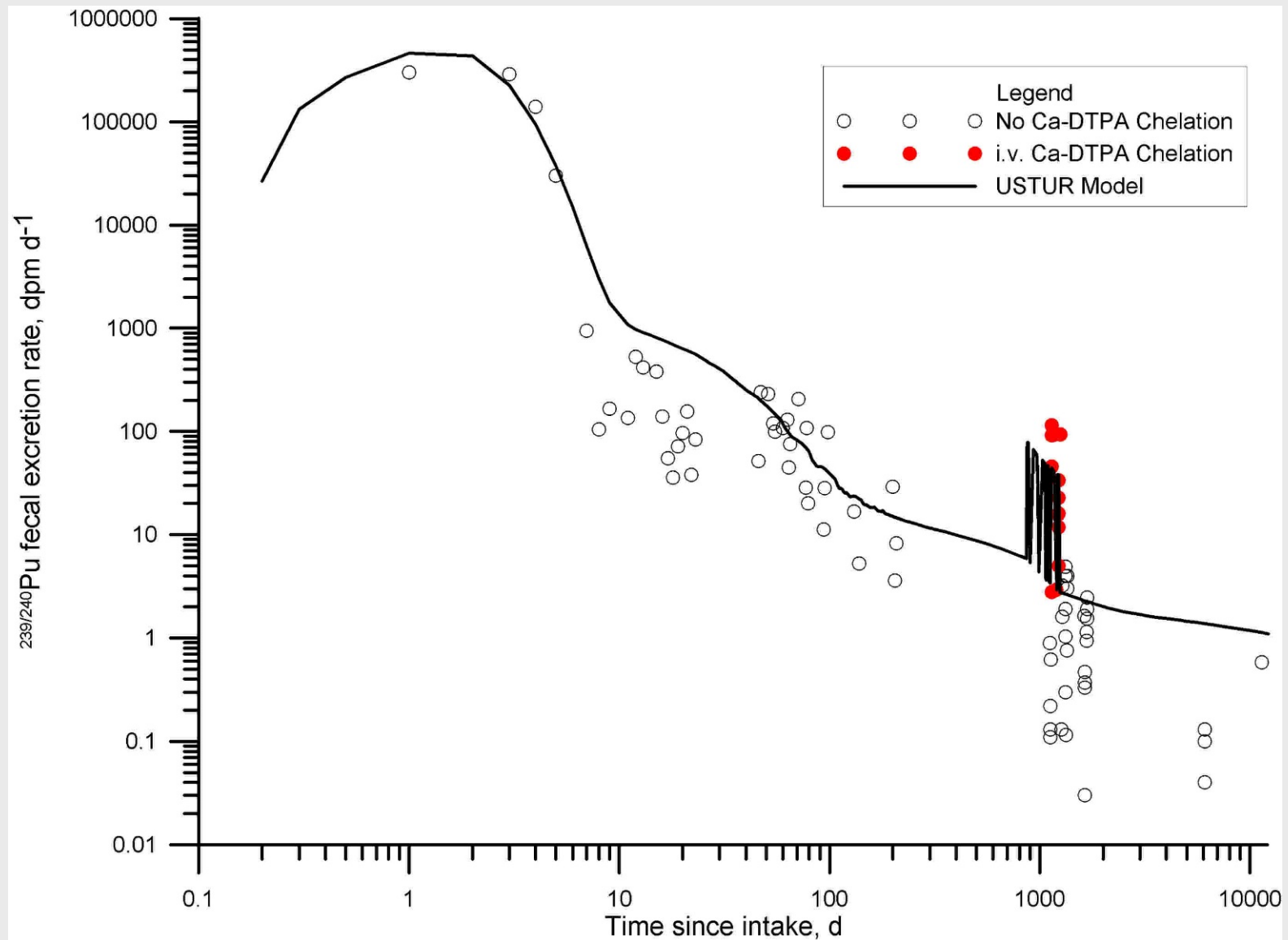



## Case 0269: Interim USTUR Model Predictions

Tissue	Tissue Content, kBq		
	Measured	USTUR Model	
		Ca-EDTA + Ca-DTPA	Untreated
Whole Body	2.280	2.289	4.225
Lungs	0.0267	0.0267	0.0267
Lymph Nodes	0.00019	0.00021	0.00021
Liver	0.937	0.814	1.623
Skeleton	1.178	1.213	2.183
Muscle, Skin, <i>etc.</i>	0.141	0.228	0.383
Kidneys	0.00169	0.00166	0.00317



## Keeping Pace with ICRP Developments!

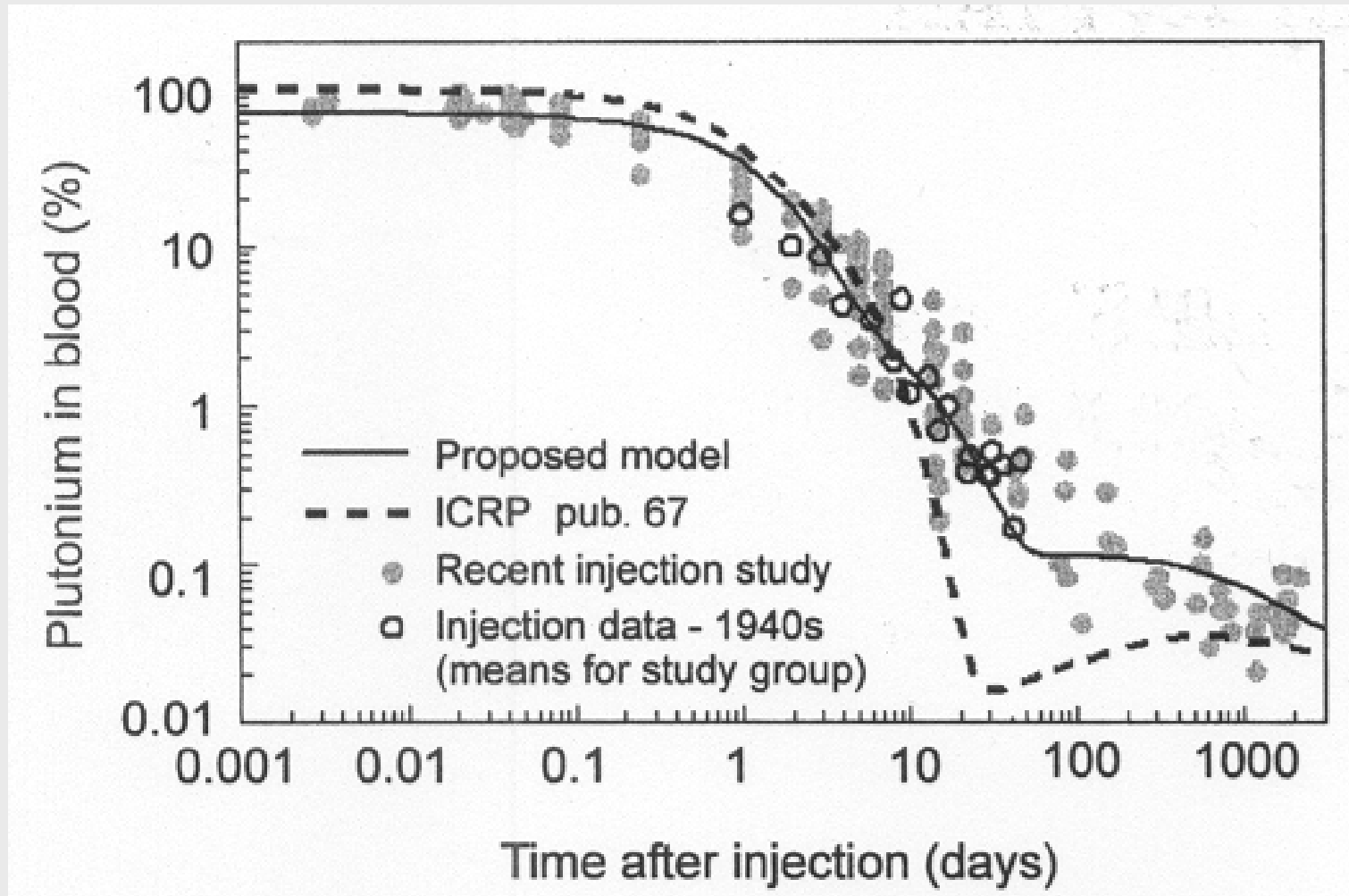

- New (UK) human volunteer studies of early excretion and organ uptake of i.v.-injected plutonium isotopes – taken from Leggett et al. (2005)



# New Pu Biokinetic Model Being Considered by ICRP

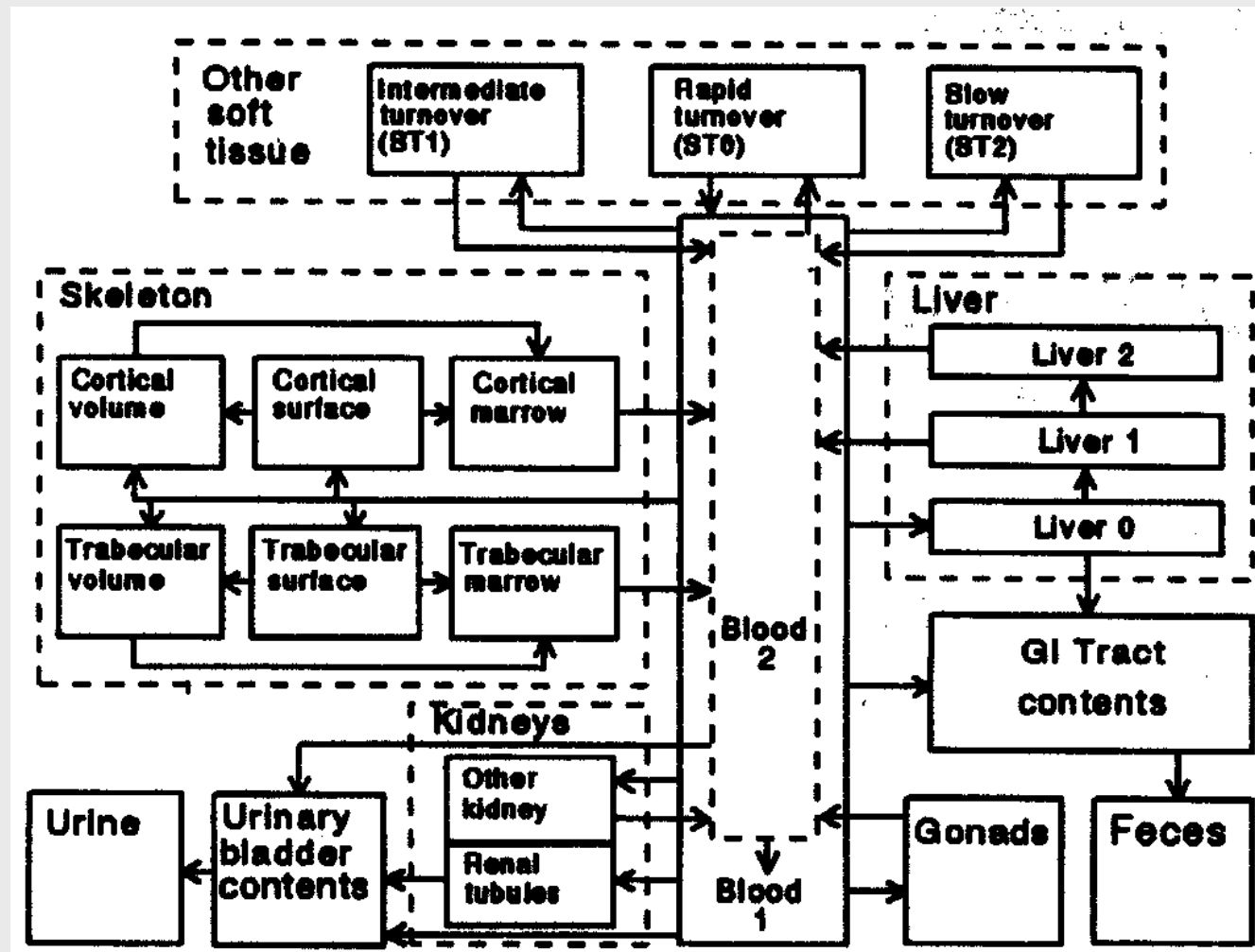

- Non-physiological pathway between soft tissue compartment ST1 and ‘urinary path’ replaced by partitioned uptake between “Blood 1” compartment and ST0 – **USTUR needs to ‘re-do’ chelation analyses!**



## USTUR's Unique Contribution to Quantifying Individual Variability in Biokinetic Rates and Tissue Doses

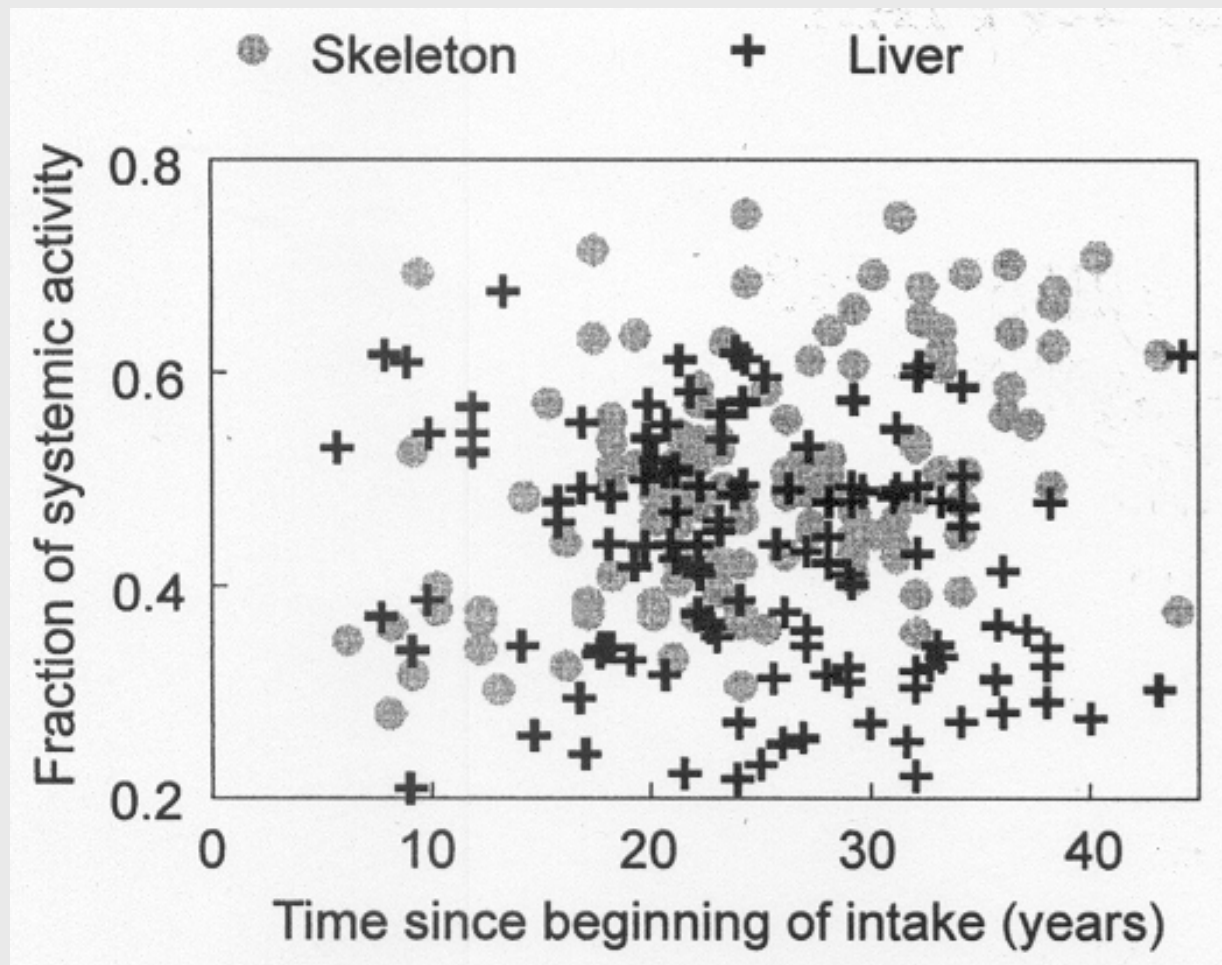

- E.g., What explains the observed variability in the ratio of skeletal:liver Pu content at death?



# General Biokinetic Model for Inhaled Plutonium

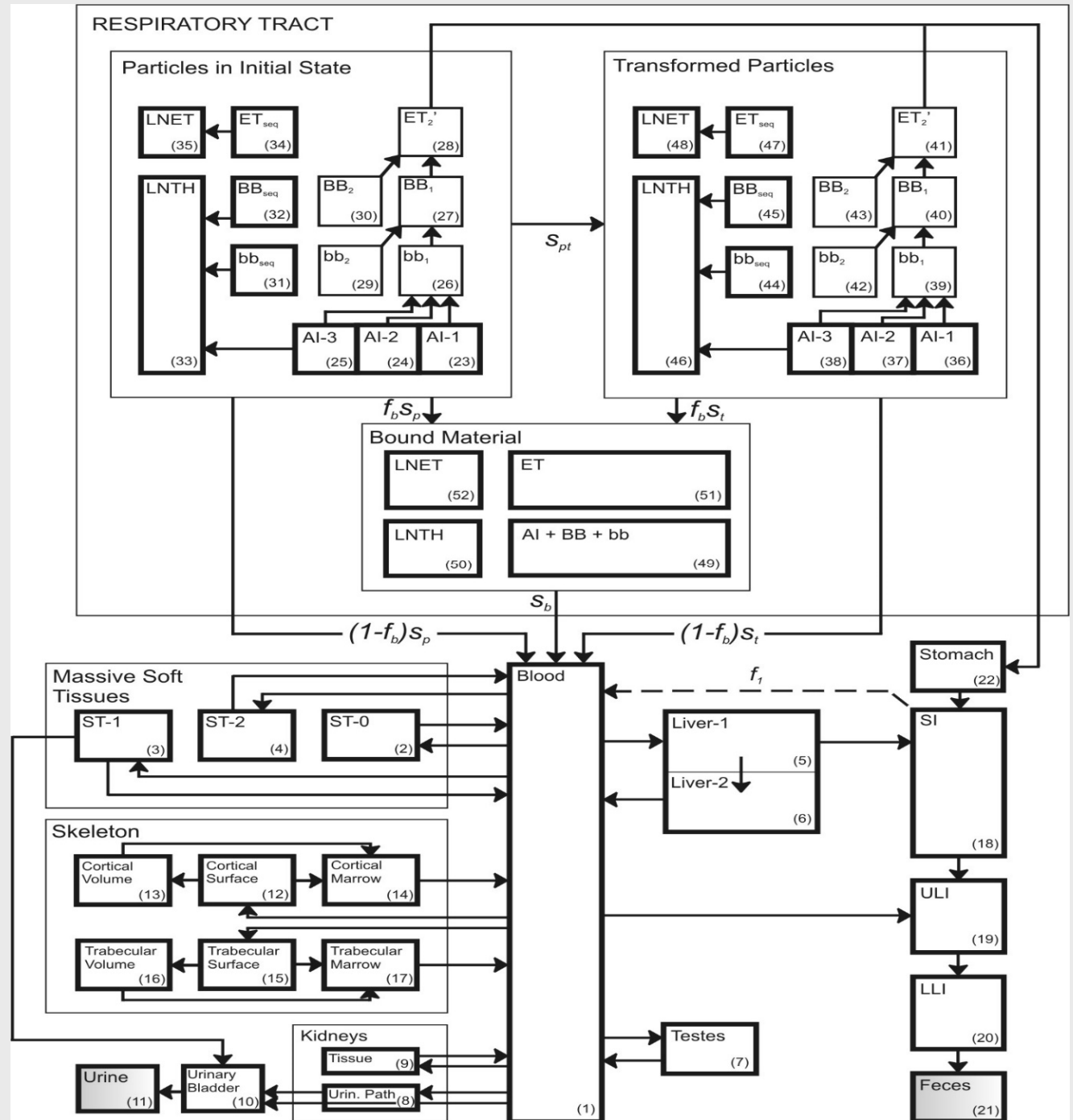







# Determine Variability in Transfer Rates for Registrant 'Population'

Solve  
Rate Matrix  
for *Every*  
USTUR  
Whole-Body  
Case – i.e.,  
*Define*  
*Human*  
*Population*  
*Distribution!*

Case 0259

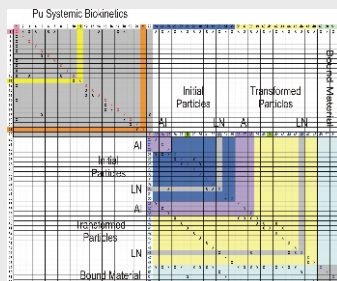

Case 0269

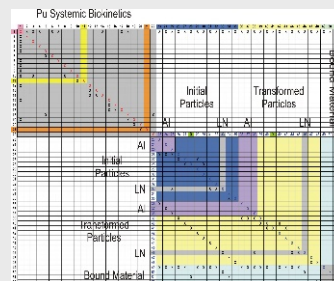

Case 0262

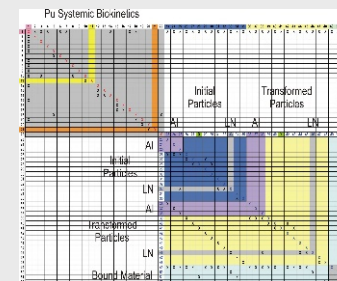

Case 0769

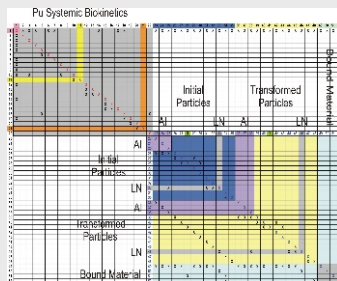

Case 0744

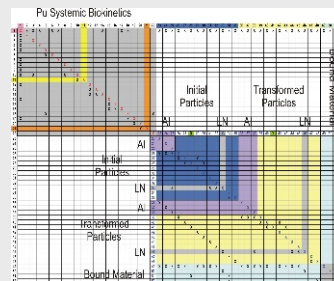

Case 1002

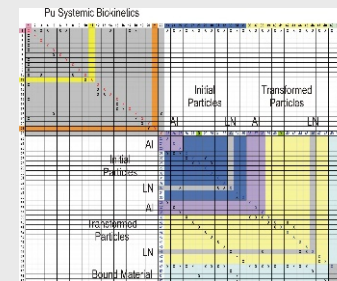

Case 1028

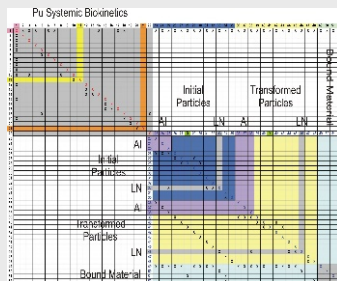

Case xxxx

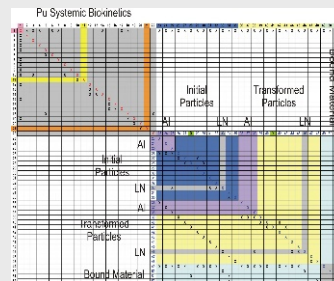

Case xxxx

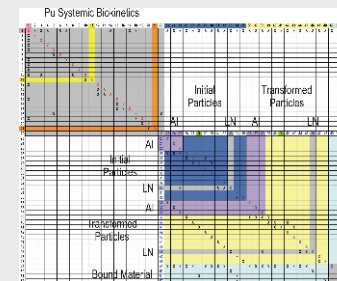



# Case #0262 – Combined Pu Wound/Inhalations

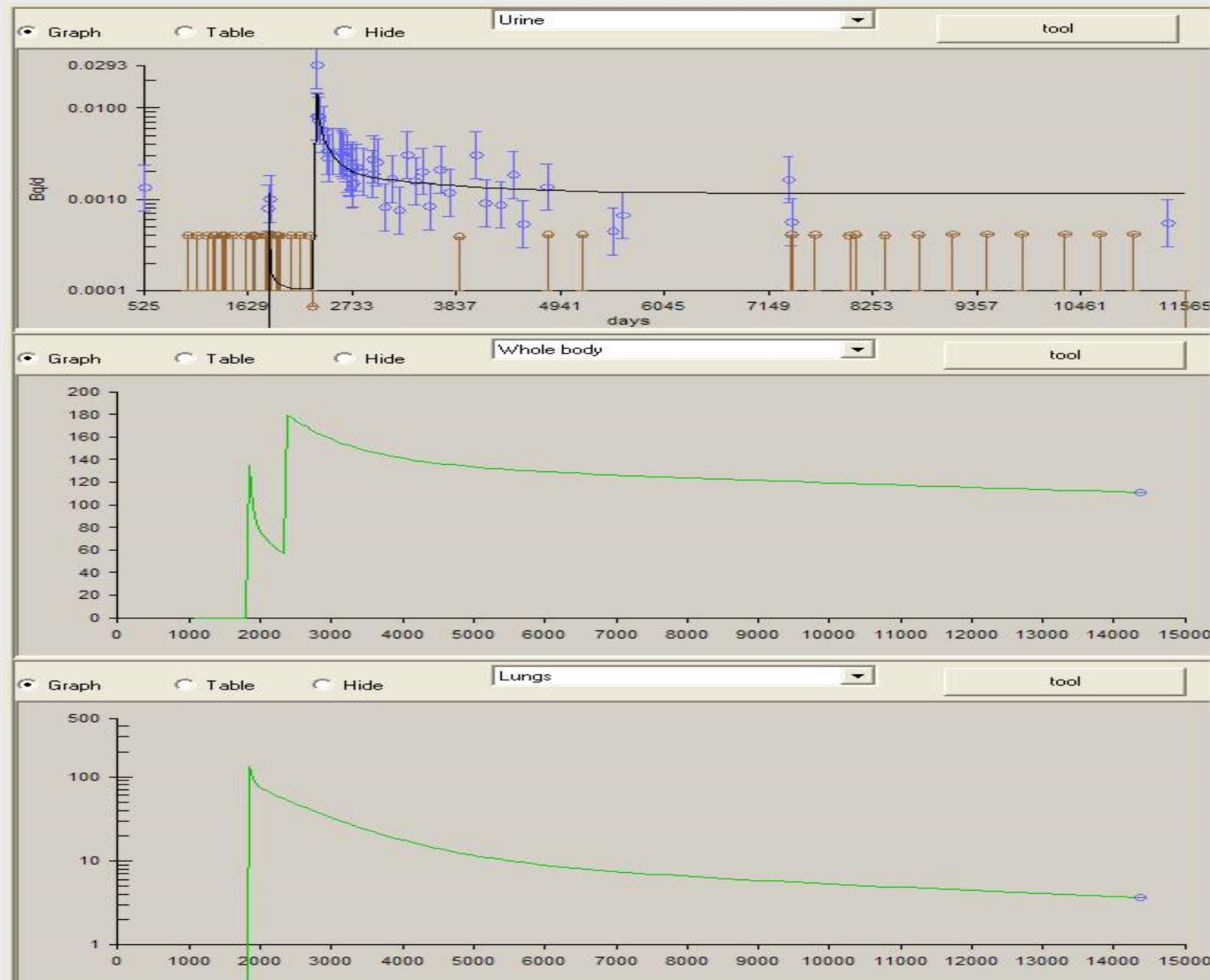



# Case #0262: Combined Inhalation/Wound Model

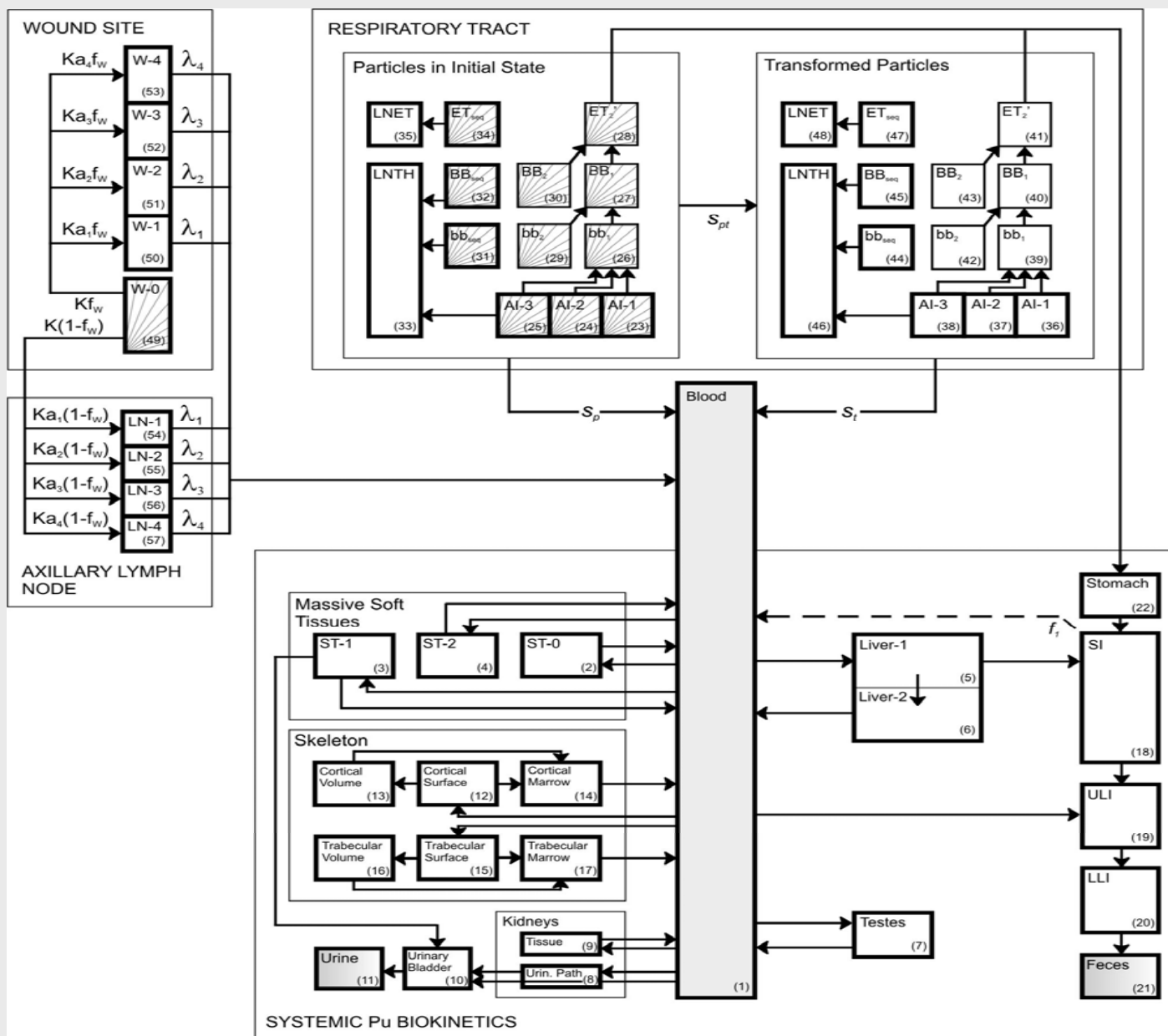



## Final Model Solution for Case #0262

- “Fits” all measured tissue contents at death (12,536 d).

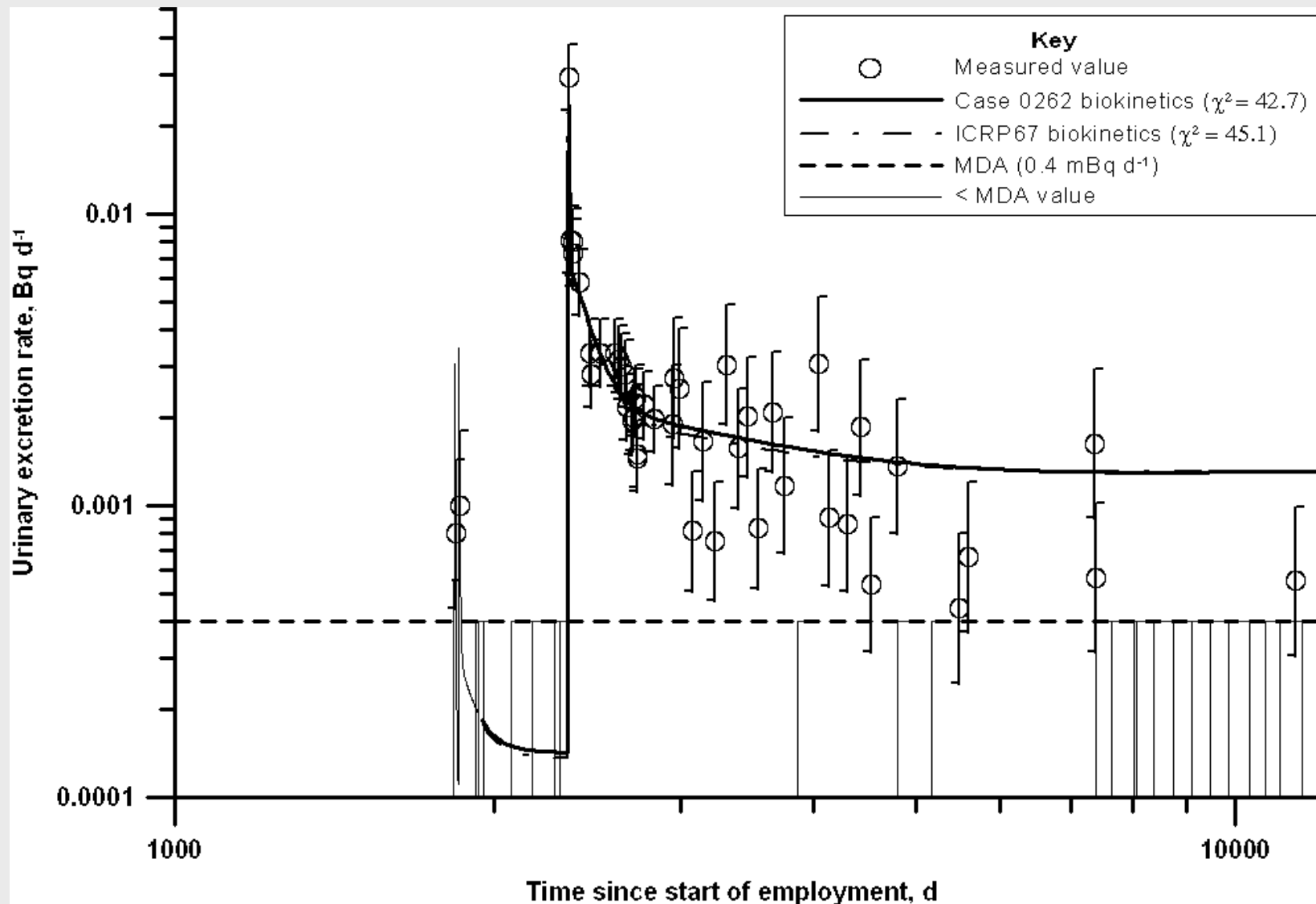



## Comparison of Model Solutions for Two Cases

Transfer Pathway	Transfer Rate, d <sup>-1</sup>		
	ICRP Reference Value	Case-specific Factor	
		Case #0259 <sup>a</sup>	Case #0262 <sup>b</sup>
Blood to Cortical bone surface	0.3235 × 0.4	× 0.515	× 0.444
Cortical bone volume to Marrow	0.0000821	× 0.55	× 0.53
Blood to Trabecular bone surface	0.3235 × 0.6	× 1.1253	× 1.133
Trabecular bone surface to Volume	0.000247	× 1.40	× 1.40 <sup>c</sup>
Trabecular bone surface to Marrow	0.000493	× 1.00	× 1.00
Trabecular bone volume to Marrow	0.000493	× 0.64	× 0.35
Trabecular marrow to Blood	0.0076	× 0.605	× 0.605 <sup>c</sup>
Blood to Liver 1	0.1941	× 1.61	× 0.928
Liver 2 to Blood	0.000211	× 0.92	× 0.90
Blood to Other kidney tissue	0.00323	× 1.255	× 0.827
Other kidney tissue to Blood	0.00139	× 0.97	× 1.00
Blood to Urinary path	0.00647	× 1.39	× 0.90
Blood to Urinary bladder content	0.0129	× 1.39	× 0.90
Blood to ST-2	0.0129	× 0.87	× 1.84
ST-2 to Blood	0.000019	× 1.00	× 1.00
Blood to Testes	0.00023	× 0.85	× 0.69
Testes to Blood	0.00019	× 1.00	× 1.00



# Next Generation Modeling!

Solve  
*Extended Rate Matrix*  
for USTUR  
Whole-Body  
Cases with  
Significant  
 $^{241}\text{Am}$   
in-growth

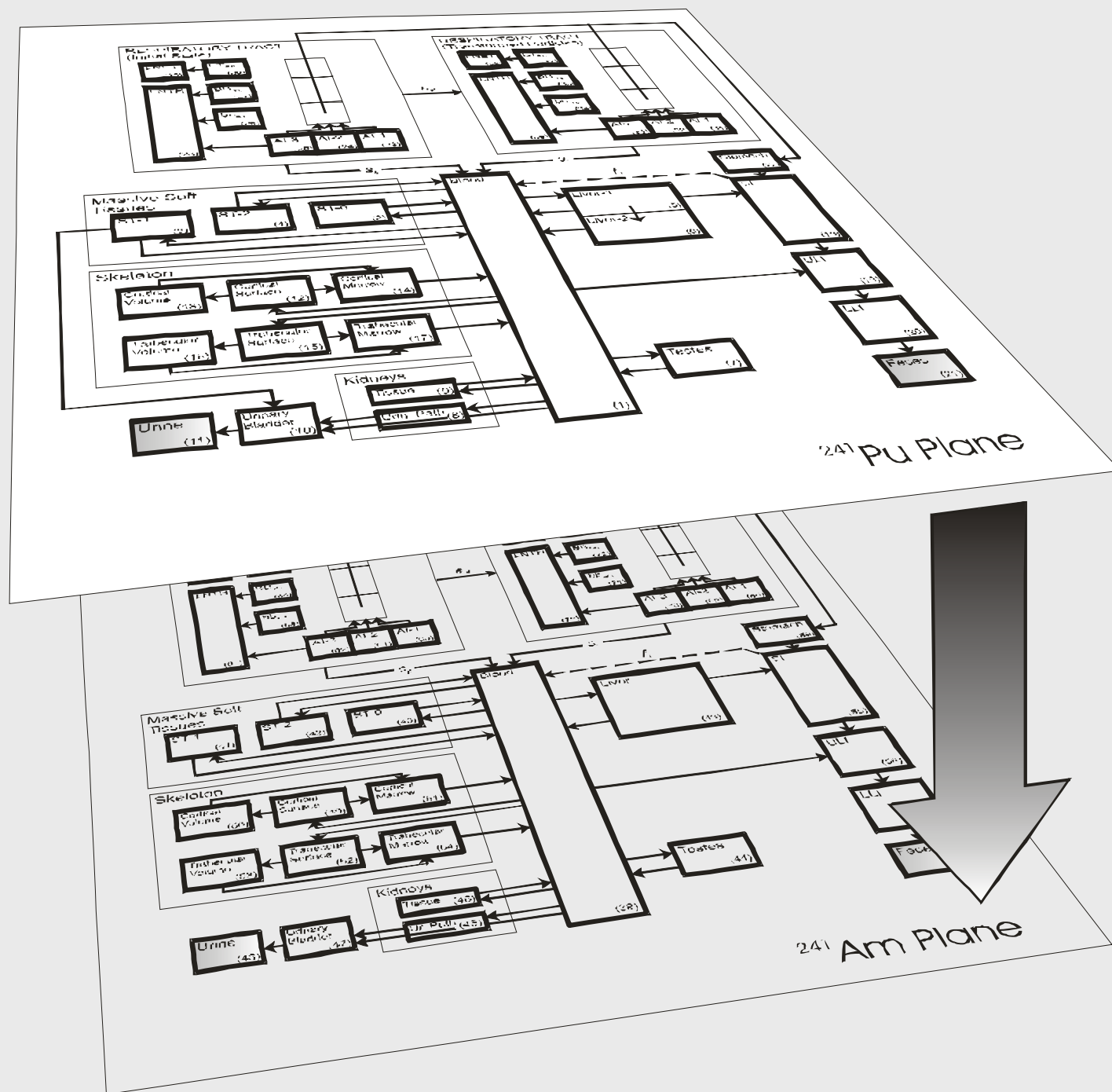



## **USTUR Helping NIOSH/OCAS in Characterizing Rocky Flats Exposures**

---

- Recurrent “issue” in being ‘claimant favorable’ to past nuclear workers exposed to insoluble plutonium is characterizing ‘Super-S’ conditions:
  - Most ‘favorable’ assumptions depend on cancer type.
- Also NIOSH needs to address calls for Rocky Flats Pu workers to be classified as a ‘Special Exposure Cohort’ (SEC).
- NIOSH has let a (small) ‘rapid response’ contract with USTUR to provide redacted file data on 115 Registrants tissue contents and health physics data:
  - 109 partial body; 6 whole body cases.



## Litigation “Issues”

---

- DOL is compensating past nuclear workers at the “More Likely Than Not At the 99 Percentile Confidence Level.”
  - Using uniformly ‘claimant favorable’ assumptions.
- Individuals with the sparsest ‘real’ data are the most likely to get compensated.
- Can be construed as .... “if we know nothing about you, we admit to ‘causing’ your cancer ...”
- Litigation ‘defense’ attempts to work to “More Likely Than Not Standard” – period – using ‘best available’ science/methodologies!





## Registrant “Longevity” – A Preliminary Look

---

- Chuck Watson (NRA/USTUR Database Consultant) has started to compare USTUR Registrant ‘survival’
- **For each case**, and particular YEAR starting work:
  - Look up U.S. Life-Table projection of remaining ‘life expectancy.’
- Current Registrant population – 384 deaths – 123 still living (but **hypothesized** ‘dead’ on 12/1/2005):
  - Mean ‘life’ currently lags survival expectancy by just 1.3 years – includes early spate of ‘self-inflicted gunshot wounds.’
- Mean ‘life’ will **increase** – with continued survival.



## Registrant “Longevity” – Continued

---

- **Whole Body Donors:**
  - All 21 died of “natural causes.”
  - Lived an average of 4 years longer than predicted.
- **Living Whole Body Donation Registrants (17):**
  - Have ‘outlived’ the life table by an average of 10.5 years – and counting!
- **Living Partial-Body Donation Registrant (116):**
  - Have ‘outlived’ the life table by an average of 7.7 years – and counting!



# **New USTUR Slogan!**

---

- **Work at a DOE Nuclear Facility in the 1940s – 1970s?**
- **Become a Whole-Body Donor!**
- **Extend Your LIFE!!!**
- **Partial-body Donations work too – but not as well!**